

# 1 An Innovative Organic Rankine Cycle Approach for High Temperature Applications

2

3 Angad Singh Panesar

4 School of Computing, Engineering and Mathematics, University of Brighton

5

## 6 Abstract

7 Organic Rankine Cycles (ORC) using toluene and hexamethyldisiloxane (MM) are put forward as a means of  
8 improving the efficiency of automotive heavy duty engines, and provide a reference for comparison in this study.  
9 Despite an efficiency improvement potential of 4-4.7%, the current ORC approach is not reaching the required fuel  
10 savings within the expected costs. As such, innovative pathways to improve the ORC performance and  
11 cost-effectiveness are of great importance to the research community. This paper presents a partial solution by means  
12 of a conceptual overview and simulation results for ORCs especially tailored for high-temperature applications. A  
13 fundamental revision of the heat transfer and expansion characteristics is presented, without increasing the system  
14 integration complexity. These characteristics are attributed to the use of formulated organic blends with toluene and  
15 MM as a significant blend component. The developed 22 criteria blend screening methodology is presented.  
16 Simulation results show that for an equivalent expansion volume flow ratio, and product of heat transfer coefficient and  
17 area, the blends offer a 22-24% improvement in the net power. This resulted in a 15-18% cost savings compared to  
18 the reference ORC. The simulations were conducted in Aspen HYSYS V8 using the Peng-Robinson and Wilson fluid  
19 property packages.

20

## 21 Keywords

22 Organic Rankine cycles; Internal combustion engines; Size and performance trade-off; Irreversibilities;  
23 High-temperature organic blends; Cost analysis

## Nomenclature

|           |   |
|-----------|---|
| $A$       | heat transfer area ( $m^2$ )            |
| $c_p$     | specific heat ( $kJ/kg^\circ C$ )       |
| $D$       | diameter (m)                            |
| $h$       | specific enthalpy ( $kJ/kg$ )           |
| $H_{vap}$ | latent heat of vaporisation ( $kJ/kg$ ) |
| $i$       | irreversibility (kW)                    |
| $L$       | volume (L)                              |

|           |   |
|-----------|---|
| $\dot{m}$ | mass flow rate (kg/s)                                   |
| $M_{wt}$  | molecular weight (g/mol)                                |
| $P$       | absolute pressure (bar)                                 |
| $\dot{Q}$ | thermal duty (kW)                                       |
| $S$       | turbine size parameter (m)                              |
| $s$       | specific entropy (kJ/kg°C)                              |
| $T$       | temperature (°C)  |
| $U$       | overall heat transfer coefficient (W/m <sup>2</sup> °C) |
| $\dot{V}$ | volume flow rate (m <sup>3</sup> /s)                    |
| $\dot{W}$ | power (kW)  |

#### *Greek symbols*

|           |                              |
|-----------|------------------------------|
| $\eta$    | efficiency                   |
| $\rho$    | density (kg/m <sup>3</sup> ) |
| $\lambda$ | thermal conductivity (W/m°C) |
| $\mu$     | viscosity (cP)               |

#### *Abbreviations*

|      |   |
|------|---|
| B100 | mid-speed high-load                                       |
| BTE  | brake thermal efficiency                                  |
| GWP  | global warming potential                                  |
| HDDE | heavy duty diesel engine                                  |
| HEX  | heat exchanger  |
| ICE  | internal combustion engine                                |
| IHE  | internal heat exchanger                                   |
| MM   | hexamethyldisiloxane                                      |
| MM80 | organic blend containing 80% hexamethyldisiloxane by mass |
| ORC  | organic Rankine cycle                                     |
| PRV  | pressure reducing valve                                   |
| T80  | organic blend containing 80% toluene by mass              |
| VFR  | volume flow ratio   |
| VLE  | vapour-liquid equilibrium                                 |

#### *Subscripts*

|     |         |
|-----|---------|
| amb | ambient |
|-----|---------|

|      |             |
|------|-------------|
| cond | condenser   |
| exh  | exhaust     |
| exp  | expander    |
| pp   | pinch point |

24

## 25 **1 Introduction**

26 The modern automotive Internal Combustion Engine (ICE) rejects up to 50% of the total fuel chemical energy in the  
27 form of waste heat, with a significant portion of this as high quality exhaust gases. Due to increasing greenhouse  
28 emissions and impending worldwide fuel consumption regulations, there is a growing interest in technologies that can  
29 even partially utilise the exhaust heat to improve the overall Brake Thermal Efficiency (BTE). This has been an  
30 intensified area of research in the last decade, where numerous methods including turbocompounding, thermoelectric  
31 generators and fluid bottoming cycles have been proposed and demonstrated for on-road vehicles [1, 2]. The potential  
32 fuel consumption reduction using any heat-to-power conversion technology is firstly dependent at least on the ICE  
33 application and the duty cycle. Highest benefits are expected in long-haul trucking which involves extended time of  
34 running at near steady speeds. As a result, it has been shown that such technologies can play a significant part in  
35 achieving future BTE goals for Heavy Duty Diesel Engines (HDDE) [3, 4]. With a focus on automotive exhaust  
36 applications, the following overview is divided into four themes: the preferred fluid bottoming cycle, optimisation of  
37 ORCs, selection of working fluids, component developments, and integration with other energy technologies and heat  
38 sources.

39

40 Amongst the fluid bottoming cycle options, Rankine, Kalina and Organic Rankine Cycles (ORC) are typically  
41 proposed. The conventional Rankine cycle presents an environmentally friendly and thermally stable solution.  
42 However, it offers challenges relating to freezing temperatures, reduced performance under cooler exhaust  
43 temperatures, requirement of higher superheating levels, relatively poor transient response and poor turbine efficiency  
44 for low capacity applications [5, 6]. The Kalina cycle, which has been initially applied to geothermal applications, offers  
45 the advantage of a good temperature match in the heat exchanger using an ammonia-water mixture. Additionally,  
46 variation in the composition of the mixture allows adapting the cycle to possible fluctuating heat source and/or sink  
47 temperatures. However, it presents challenges relating to packaging of the separator and the Internal Heat Exchanger  
48 (IHE), complexity in exploiting different heat streams simultaneously, higher system pressures, and corrosion and  
49 stress cracking with some common engineering materials [7, 8]. The frequently cited above reasons hinder the  
50 adoption of Rankine and Kalina cycles for automotive applications. As a result, the literature review indicated that the  
51 use of relatively simple ORC systems appears to be the leading heat-to-power conversion technology for long-haul  
52 truck applications when considering, quality of heat sources ( $<450^{\circ}\text{C}$ ), output capacities (5-25 kW), conversion

53 efficiencies (10-15%), transient driving conditions, technology readiness level, absolute fuel consumption, space  
54 availability and weight penalty [9, 10].

55  
56 The overall conversion efficiency of an ORC largely depends on the selected working fluid (e.g. refrigerant,  
57 hydrocarbon), its associated cycle operating mode (e.g. subcritical, supercritical), the chosen expansion machine  
58 (e.g. piston expander, radial turbine) and the system architecture (e.g. thermal, sub-system) [9, 11]. This presents a  
59 complex multi-dimensional challenge to find universal solutions, which are vital to reach the economies-of-scale.  
60 Attempts using, regression models for evaluating design implications, parametric and thermo-economic optimisation  
61 using genetic algorithms and energy integration methodologies coupled with multi-objective optimisation, have all  
62 been considered in the literature [12-15]. Adding to the above challenge, organic fluids present the drawbacks of  
63 thermal stabilities much below the exhaust gas temperatures, and/or environmental and safety concerns.

64  
65 For low-temperature exhaust heat, Domingues et al. suggested the use of R245fa due to the higher heat exchanger  
66 effectiveness over water [5]. Whereas, for medium-temperature exhaust heat, Larsen et al. showed ethanol as a  
67 suitable option [11]. With an increased emphasis on Global Warming Potential (GWP), Yang et al. recently indicated  
68 an ultra-low GWP refrigerant (R1234yf) optimal from a thermo-economic point of view [16]. To offer improved thermal  
69 stability options, Fernandez et al. recommended hexamethyldisiloxane (MM), while Seher et al. showed a higher  
70 performance potential using toluene [17, 18]. Additionally, the modelling study to provide optimisation guidelines by  
71 Maraver et al. also suggested the use of toluene [19].

72  
73 Key ORC components such as heat exchangers and expanders are additionally becoming more viable due to a series  
74 of recent technological advancements and similarity to the current automotive components. Yang et al. and Zhang et  
75 al. have recently demonstrated prototypes of fin-tube and spiral-tube evaporators, respectively [12, 20]. Zhang et al.  
76 have additionally achieved adiabatic efficiencies in excess of 70% with a single-screw expander [20]. While, Wang et  
77 al. demonstrated a nominal 5kW heat activated cooling unit under laboratory conditions and achieved isentropic  
78 efficiencies in excess of 80% with a scroll expander [21].

79  
80 ORCs have also been proposed in combination with other technologies including refrigeration cycles and  
81 thermoelectric generators. Simulation results by Yilmaz et al. showed that the air-conditioning needs of an intercity  
82 bus can be realised using the exhaust gas energy in combination with R134a and R245fa as the working fluids [22].  
83 While, Shu et al. considered the use of thermoelectric generators for higher temperature heat recovery, followed by  
84 ORCs for lower temperature heat recovery in a theoretical study [23]. This architecture was suggested primarily to  
85 address the thermal stability issue of organic fluids. To exploit exhaust gas and engine coolant heat simultaneously,

86 dual-loop cascade arrangements and thermal-oil loop transferring the coolant and exhaust heat were also theoretically  
87 considered [24, 25]. These configurations allowed higher heat exploitation, however, the challenges relating to system  
88 size, weight, cost, control and complexity could be prohibitive for automotive applications.

89  
90 It is important to highlight that the above reviewed simulation and experimental studies were found to produce a broad  
91 range of overall BTE increase (1-6% in absolute terms) for the considered base engines. This was because different  
92 studies have utilised different engine platforms, engine speed-load points, heat sources, qualities, quantities, working  
93 fluids, ORC system architecture, boundary conditions and component efficiencies, giving different overall conversion  
94 efficiencies. Furthermore, the rebound effect was acknowledged in very few of the reviewed studies, i.e. fuel  
95 improvements may encourage the consumption of other energy forms which may partially offset the gains [3, 26].  
96 Since the interpretation of the published results is not straight forward, it is advantageous to re-simulate a reference  
97 case for comparison.

98  
99 This paper firstly presents the simulation results for two higher thermal stability conventional ORCs using an IHE to act  
100 as a reference for comparison. The reference results were the end product of a system size and system performance  
101 trade-off study to quantify the practical improvement potential. Secondly, the shortcomings of such conventional ORCs  
102 targeting automotive exhaust heat recovery are detailed. Thirdly, to partially address the shortcomings and facilitate  
103 the introduction of ORC systems, an innovative ORC approach is presented conceptually. To realise the proposed  
104 ORC approach, fluid blends with unique heat transfer and expansion characteristics are formulated, extending the  
105 analysis of parallel works [9, 27]. For equivalent heat transfer footprint and the expansion machine size, the  
106 performance variation between the reference ORC and the proposed ORC is calculated. Finally, the economic  
107 analysis based on the estimates from step count and exponential methods is presented to quantify the benefit of the  
108 proposed ORC approach. For a comprehensive understanding, the system and performance parameters were based  
109 on the energy and exergy equations in all the specific points of the cycle. The advanced modelling tool, Aspen  
110 HYSYS V8 was used, which contains physical, chemical and thermodynamic data for a wide variety of chemical  
111 compounds, as well as a selection of thermodynamic models required for accurate simulation of thermal and chemical  
112 systems [28].

## 114 **2 Reference ORC**

### 115 **2.1 System overview**

116 The ICE offers at least four streams of waste heat, namely, exhaust gases, engine coolant, engine lubricant and  
117 charge air. However, only exhaust heat recovery, downstream of the aftertreatment devices, from a 12.8 litre (L),  
118 Euro 6, truck engine model was considered at the mid-speed high-load condition (B100) [29]. This was so, since

performance and economic competitiveness of typical fluid bottoming cycles is proportional to the energy and exergy levels of the targeted heat source, respectively. Targeting exhaust heat then provides a good starting point and an attractive opportunity for reducing emissions whilst using a wasted resource. Furthermore, it is important to bear in mind that the present market niche for automotive ORCs is dependent on architectural simplicity. Hence, ORCs with turbine-bleeding arrangements that have shown thermodynamic and economic merits in other applications are not considered practical here [30]. Table 1 summarises some of the engine performance parameters at B100, the input variables for heat recovery analysis and the initial ORC modelling assumptions.

Figure 1a presents the simplified schematic of the ORC system considered in this study, and Fig. 1b depicts the associated Temperature-Duty (T-Q) sketch for the superheated subcritical process. Excluded from the schematic is a storage tank prior to the pump, and the bypass valve for the exhaust heat exchanger (exhaust side), the internal heat exchanger (high-pressure side) and the expansion machine. These components along with a control unit are required to enable the functioning of the system over a complete drive cycle.

The exhaust heat (A-B) is recovered in the exhaust heat exchanger (HEX), and the high-pressure pre-heated liquid is converted into superheated vapour (2-3). Assuming steady-state and steady-flow system, the energy transferred to the fluid (neglecting heat losses) is given as:

$$\dot{Q}_{HEX} = \dot{m}_{exh} c_p (T_A - T_B) \dots (1)$$

Where,  $\dot{Q}$  is the thermal duty (kW),  $\dot{m}$  is the mass flow rate (kg/s),  $c_p$  is the specific heat (kJ/kg°C) and  $T$  is the temperature (K). Additionally, neglecting the kinetic and potential energies, the irreversibilities (internal and external combined) is calculated using the specific enthalpy and entropy of the fluid at the inlet (Pt. 2) and exit (Pt. 3) conditions, and the mean temperature of the heat source as [31]:

$$\dot{I}_{HEX} = T_{amb} \dot{m}_{fluid} [(s_3 - s_2) - \{(h_3 - h_2)/T_{exh\ mean}\}] \dots (2)$$

Where,  $\dot{I}$  is the irreversibilities (kW),  $s$  is the entropy (kJ/kg°C) and  $h$  is the enthalpy (kJ/kg). The temperature differences along A-B and 2-3 can be seen as a direct measure of irreversibilities.

The high-pressure superheated fluid is then passed through an expansion machine (3-4, dynamic or positive displacement). The work is transferred electrically (via generator) or mechanically (via gear train). The expansion and pumping processes are non-isentropic, and the power output is given as:

$$\dot{W}_{exp} = \dot{m}_{fluid} (h_3 - h_{4\ ideal}) \eta_{exp} \dots (3)$$

Where,  $\dot{W}$  is the work done or absorbed (kW) and  $\eta$  is the isentropic efficiency. The expansion irreversibilities expressed using inlet (Pt. 3) and exit (Pt. 4) fluid conditions for the real expansion is calculated as:

$$\dot{I}_{exp} = T_{amb} \dot{m}_{fluid} (s_4 - s_3) \dots (4)$$

152

153 To internally utilise the considerable exergy exiting the expansion machine, and hence avoid the potential loss in the  
 154 condenser, an internal heat exchanger (IHE) is utilised. The vapour side (low-pressure side) of the IHE reduces the  
 155 high-temperature low-pressure vapour exiting the expansion machine to a low-temperature low-pressure vapour prior  
 156 to the condenser inlet (4-5). In doing so, the high-pressure low-temperature liquid exiting the pump (high-pressure  
 157 side) recovers the enthalpy difference and is raised to a higher temperature (1-2). The internally transferred heat and  
 158 the irreversibilities attributed to this process are calculated as:

$$159 \dot{Q}_{IHE} = \dot{m}_{fluid} c_p (T_4 - T_5) \dots (5)$$

$$160 \dot{I}_{IHE} = T_{amb} \dot{m}_{fluid} [(s_5 - s_4) + (s_2 - s_1)] \dots (6)$$

161

162 The fluid then rejects the heat to the air (C-D) and is converted from low-pressure vapour to sub-cooled liquid (5-6) in  
 163 the condenser. The sub-cooling needs to be limited to a small amount to reduce the impact on the total condenser  
 164 size. The energy transferred from the fluid and the condensing irreversibilities are calculated as:

$$165 \dot{Q}_{cond} = \dot{m}_{air} c_p (T_C - T_D) \dots (7)$$

$$166 \dot{I}_{cond} = T_{amb} \dot{m}_{fluid} [(s_6 - s_5) - \{(h_6 - h_5)/T_{air\ mean}\}] \dots (8)$$

167

168 To complete the closed-loop cycle, the sub-cooled liquid at the pump inlet is pressurised to enter the IHE (6-1). The  
 169 power consumed by the pump and the pumping irreversibilities are calculated as:

$$170 \dot{W}_{pump} = \dot{m}_{fluid} (h_{1\ ideal} - h_6) / \eta_{pump} \dots (9)$$

$$171 \dot{I}_{pump} = T_{amb} \dot{m}_{fluid} (s_1 - s_6) \dots (10)$$

172

173 Finally, the net power ( $\dot{W}_{net}$ ) and the thermal efficiency ( $\eta_I$ ) are described as:

$$174 \dot{W}_{net} = \dot{W}_{exp} - \dot{W}_{pump} \dots (11)$$

$$175 \eta_I = \dot{W}_{net} / \dot{Q}_{HEX} \dots (12)$$

176

## 177 **2.2 Rational for the reference**

178 In automotive ORCs, negligible environmental impact and higher thermal stability requirements are considered  
 179 essential for the chosen working fluid. Implementation of the mobile air-conditioning directive in the European Union  
 180 led to the banning of R134a [32]. Such regulations in the future may also apply to automotive ORCs requiring the use  
 181 of fluids with GWP less than 150. This may exclude the commercially popular R245fa, which is often suggested for  
 182 stationary and marine ORCs [1, 11]. New selection criteria of low GWP and improving technologies to reduce  
 183 flammability risks have led to a revived interest in using hydrocarbons and its derivatives [18, 33].

184

185 The thermal decomposition issue was primarily addressed in the literature using two avenues: firstly by using  
186 thermal-oil loops and secondly by using higher thermal stability fluids [18, 34]. Due to the additional size, complexity  
187 and weight (e.g. due to the gas-oil heat exchanger), thermodynamic (e.g. additional exergy destruction), and cost  
188 (estimated at an additional 20%) considerations, the thermal-oil loop approach was excluded as a potential solution in  
189 the considered application [9, 17]. It is stated that the molecular make-up of organic fluids fundamentally precludes the  
190 possibility of an ideal fluid [11, 35]. Nonetheless, the two fluids offering a preferred trade-off, and hence, proposed in  
191 the literature for high-temperature applications include toluene and MM [18, 36].

192

193 Figure 2 presents the net power results with increasing pressure for the commonly suggested high-temperature fluids  
194 utilising the modelling assumptions from Table 1. The maximum cycle pressure was normalised to the critical  
195 pressure. Although, these results are based on a non-constrained expansion machine size, nevertheless, the higher  
196 performance of toluene and MM validates the literature findings [6, 17]. The net power results for R245fa are also  
197 included, these were 35-50% lower than those of toluene and MM. The more complex fluids such as D5 and D6 were  
198 excluded from consideration due to freezing temperatures higher than  $-40^{\circ}\text{C}$ . Freezing temperatures below  $-40^{\circ}\text{C}$   
199 (i.e. similar to the conventional engine coolant) are required for automotive applications. Furthermore, complex fluids  
200 are shown to offer lower thermodynamic performance and also exhibit technical constraints for expansion machine  
201 technology [17, 19]. Hence, toluene and MM cycles offer an appropriate reference for comparison for exploitation of  
202 exhaust heat. These two fluids offer the advantages of a relatively high thermal stability, high molecular weight, low  
203 GWP and the use of an IHE.

204

### 205 **2.3 Parametric analysis**

206 To demonstrate the cycle behaviour of an ORC with an IHE, two parametric studies are presented using toluene as an  
207 example: variation in maximum cycle pressure for dry saturated vapour expansion (Fig. 3a) and variation in maximum  
208 cycle temperature for fixed pressure expansion (Fig. 3b). This was so, since for assumed fixed condensing  
209 temperature, minimum pinch point temperature differences and isentropic efficiencies (Table 1), the cycle  
210 performance was primarily a function of the cycle pressure and the degree of superheat.

211

212 In both the cases, with either increasing pressure or superheat, the exhaust HEX duty decreased (due to pinch point  
213 limitation), while the IHE duty increased (due to increasing expansion exit enthalpy). As the IHE partially preheated the  
214 working fluid, the average heat addition temperature increased, which contributed towards the thermal efficiency  
215 increase [17]. With increasing pressure, a noticeable level of net power improvement was only observed up to a cycle  
216 pressure of 16bar (Fig. 3a), whereas with increasing temperature, the net power decreased (Fig. 3b). Since the



217 context for ORC operation here is overall conversion efficiency (i.e. net power) rather than thermal efficiency,  
218 expansion inlet temperature just slightly above the dry saturated vapour temperature (i.e. 5°C superheat) was chosen  
219 for the considered dry fluids.

220  
221 Note that superheating under fixed evaporator and condenser pressures offered a system size advantage,  
222 i.e. reduction in expansion Volume Flow Ratio (VFR). The 60°C superheat reduced the VFR from 17.4:1 to 16.5:1  
223 (Fig. 3b). However, this advantage does not justifies neglecting the drawbacks of large superheating (e.g. increased  
224 system size). Furthermore, evaporators are typically designed to handle less than 10% of the total load in vapour  
225 form. High superheating levels may then require the dedicated use of a superheater.

226  
227 The parameters in Fig. 3a at 16bar can also be used to illustrate how the IHE interaction affected the heat recovery,  
228 the net power and the condenser load compared to a simple ORC without IHE (where  $\dot{Q}_{in} = \dot{Q}_{HEX} + \dot{Q}_{IHE}$ ). The cycle  
229 with an IHE utilised a smaller heat input (103 vs. 138kW) for obtaining the same net power output (16.6kW), hence it  
230 had a better thermal efficiency (16.2 vs. 12.1%) and reduced the load on the air condenser (86 vs. 121kW). The  
231 combined heat ( $\dot{Q}_{HEX} + \dot{Q}_{IHE}$ ) used by the recuperated cycle was roughly constant to the net heat ( $\dot{Q}_{in}$ ) into the  
232 non-recuperated cycle. This was because the presence of the IHE roughly compensated for the change in heat  
233 addition as a function of pressure and temperature. The net power was unchanged either with varying cycle pressure  
234 or with varying cycle temperature. This was because the specific work was only a function of pressure difference  
235 across the expansion. In summary, cycles with an IHE decreased the heat recovery efficiency, had no impact on the  
236 net power, and hence, decreased the condenser load. Note the exclusion of low-temperature heat recovery is an  
237 advantage for exhaust heat recovery, but not for the heat streams that are already a load on the engine cooling  
238 module.

#### 240 **2.4 Size and performance trade-off**

241 In order to quantify the practical performance improvement potential using toluene and MM, a size and performance  
242 trade-off study was conducted for the four major system components. These being the size of the expansion machine,  
243 the exhaust heat exchanger, the internal heat exchanger and the air condenser. As a first approximation, the following  
244 was considered as an indicator of relative size variation for a heat transfer component. It was assumed that the overall  
245 heat transfer coefficient ( $U$ , W/m<sup>2</sup>°C) remained relatively unchanged for a particular fluid under a fixed process type.  
246 Therefore,  $UA$  (W/°C), where  $A$  (m<sup>2</sup>) is the heat transfer area, was considered as an indicator for the relative heat  
247 transfer size. Similarly, the VFR of the expansion machine was considered as an indicator of the relative expansion  
248 machine size for a particular fluid under a fixed process type.

250 Figure 4a shows the influence of the VFR on the net power. The maximum net power for toluene was achieved at a  
251 high VFR value of 40:1. However, such levels of VFRs are beyond the reach of any efficient single-stage expansion  
252 machine. As a trade-off, the design point VFR was reduced to 14:1. This was so, since the net power improvement  
253 with VFRs above this value was relatively insignificant to justify the added design intensity, size and the associated  
254 costs. A similar trade-off approach for MM resulted in a design point VFR of 12:1.

256 Figure 4b shows the influence of the exhaust heat exchanger  $UA$  values on the net power. There is a region beyond  
257 which the  $UA$  values increased for a negligible improvement in power. This region corresponded to a minimum pinch  
258 point temperature difference of 25-35°C for both the fluids. Since an ideal IHE has no impact on the expansion power,  
259 Fig. 4c shows that the figure of merit to assess the impact of IHE was the cycle thermal efficiency.  $UA$  values  
260 corresponding to pinch point value of 10°C for both the fluids were considered near-optimal.

262 Finally, Fig. 4d shows the influence of the air condenser  $UA$  value on the net power. A realistic trade-off with this  
263 component is one of the vital modelling assumptions, since the performance of any fluid bottoming cycle is very  
264 sensitive to the heat rejection limit. Additionally, overly optimistic condensing temperatures cannot be considered as a  
265 norm with the existing demands on the modern engine cooling module. Assuming the addition of an air cooled ORC  
266 condenser after the engine radiator, the temperature of the available cooling air was then 40°C (Fig. 5). By limiting the  
267 air in the engine bay to 60°C, the near-optimal region then corresponded to an average design condensing  
268 temperature of 70°C for both the fluids (Fig. 4d). To give an appreciation of the challenge this brings to the engine  
269 manufacturers and original equipment suppliers, Fig. 5 shows the relative size of the various heat transfer elements in  
270 the engine cooling module based on their thermal duty at B100.

272 Table 2 summarises the key system, size and design intensity, and performance parameters for toluene and MM  
273 cycles based on the fixed design point values selected in Fig. 4. Note that, selecting larger  $UA$  and VFR values will  
274 reduce the heat transfer irreversibility and increase the performance, respectively, but will have a negative impact on  
275 system packaging and cost. It was seen that the toluene and MM cycles were 11.1-13.4% thermally efficient, and  
276 could potentially offer an additional 4-4.7% of engine power. MM and toluene both required high VFRs (12:1, 14:1)  
277 making them better suited to large single-stage radial turbines and piston expanders [37].

### 279 **3 Problem definition for the conventional ORC**

280 The potential overall fuel consumption improvements using toluene and MM cycles can play a significant part in  
281 achieving the impending fuel consumption regulations. However, the conventional ORC approach for exhaust heat  
282 recovery is still not reaching the required fuel savings within the expected costs. Since ORC systems are only 10-15%

283 efficient, considering the irreversibilities in the ORC may offer a focused research direction in improving the  
284 performance and cost-effectiveness of the system at a very fundamental level. For this consider Fig. 6, which presents  
285 the component irreversibility contributions in the design point toluene cycle. It is seen that the HEX made the highest  
286 contribution (40%, 12kW), closely followed by the condenser (29%, 8.7kW), and then by the expander  
287 (19%, 5.6kW). Contributing to the high heat transfer irreversibilities was the near isothermal phase-change and the  
288 high condensing temperature. The relatively high irreversibility contribution due to the expander was related to the  
289 realistic isentropic efficiency of 65%. The irreversibility equations presented in Section 2.1 were utilised to produce  
290 Fig. 6.

291  
292 A means to address the heat transfer irreversibility drawbacks in the literature was by employing a supercritical cycle,  
293 especially using ethanol [38]. A supercritical cycle offers lower HEX irreversibilities, since it avoids near isothermal  
294 evaporation, and allows the exclusion of the IHE, since the IHE duty decreases with increasing pressure for a fixed  
295 maximum temperature [9]. Nonetheless, under high source temperatures ( $\approx 400^\circ\text{C}$ ) and high source-to-sink  
296 temperature differentials ( $\approx 350^\circ\text{C}$ ), this is typically challenging in practice due to the excessive system pressures  
297 ( $>65$  bar, ethanol) and the need for high expansion VFRs ( $>40:1$ , ethanol) [9, 17].

298  
299 Toluene and MM cycles have sub-atmospheric condensing pressures at typical engine radiator temperature levels  
300 ( $85\text{-}95^\circ\text{C}$ ). In addition, the use of an IHE introduces additional controls, hardware, complexity and cost for the ORC  
301 system. Despite these challenges, the concept of internal heat recuperation is particularly useful for automotive  
302 exhaust heat recovery to limit the size of the additional air-cooled condenser in an already demanding engine cooling  
303 module. The above discussion (Fig. 2 and Table 2) then indicates that alternative avenues, which attempt to retain the  
304 favourable characteristics of toluene and MM, while offering superior performance, remain a theme of investigation.  
305 Note that due to a lower performance potential and thermal stability concern, blends with significant R245fa and  
306 n-pentane concentrations as suggested by Le et al., were not considered in the current case [39].

## 308 **4 Proposed ORC**

### 309 **4.1 Method overview**

310 To improve the case for ORCs, a study was undertaken to identify methods that would translate to noticeable benefits.  
311 An identified path was to formulate novel organic fluid blends with unique heat transfer and expansion characteristics,  
312 while retaining Toluene and MM as a noticeable blend component. Such a research direction is novel to the current  
313 research trends in the automotive sector, which are typically aimed towards component development and  
314 improvements in component efficiencies to make the ORC systems cost-effective [4, 18]. Although, efficient HEXs and

315 high VFR expansion machines will be vital in the deployment of ORC systems, these approaches only indirectly  
316 address the fundamental cycle drawbacks.

317  
318 The blend screening methodology, presented in Table 3, was developed and applied to examine over 225  
319 documented Toluene and MM blends [40-42]. It has been shown that an incorrect selection of the blend may result in  
320 poorer thermodynamic and economic performance over the pure fluid counterpart [43]. Hence, extending upon the  
321 earlier studies, the current screening methodology consisted of 22 criteria [9, 27]. To illustrate the primary screening  
322 criteria, Fig. 7b presents the hypothetical T-S sketch of the desired ORC. This is contrasted to Fig. 7a, which depicts  
323 the hypothetical T-S sketch of a conventional ORC. The improved expansion and the unique heat transfer  
324 characteristics, which collectively can offer an improved energy conversion concept and a higher energy density  
325 solution are summarised below:

- 326 ▪ Property 1 and/or 2: An increased latent heat (i.e. reduced mass flow rate) and/or a higher vapour density at the  
327 minimum cycle pressure. This increases the system temperature and pressure differential for a fixed expansion  
328 machine size.
- 329 ▪ Property 3: A low temperature variation during condensation to mirror a low heat sink temperature rise. This  
330 reduces the heat transfer irreversibilities and offers lower average condensation temperatures.
- 331 ▪ Property 4: A high temperature variation during evaporation to mirror the high heat source temperature drop. This  
332 reduces the heat transfer irreversibilities and increases the average heat addition temperature.
- 333 ▪ Property 5: Retention of high concentration of Toluene and MM. This attempts to retain the advantages associated  
334 with higher molecular weight, higher thermal stability and internal heat recuperation.

335  
336 The screening results were limited to the selection of just one blend each for Toluene and MM by marginally tightening  
337 the initial screening criteria. The two resulting blends were termed T80 and MM80, based on toluene and MM  
338 percentage by mass, e.g. T80 corresponding to 80% toluene. An attempt is made in Section 4.4 to compare the  
339 relevant blend properties using the recommended fluid property packages. Additionally, the Vapour-Liquid Equilibrium  
340 (VLE) behaviour was validated against the available numerical and/or experimental data [40-42, 44]. For example,  
341 Fig. 8 shows the VLE behaviour of T80 at 10 bar within the 2°C error criterion for a minimum of 10 data sets  
342 (property 6). Note that, the second blend constituents will be disclosed in a subsequent article, following  
343 experimentation. A further consideration in the selection of the blend constituents was the high availability in the  
344 market place, and a demonstrated use in the chemical and process industries (property 7).

345  
346 It is important to highlight that the evaporation and condensation characteristics of the proposed blend (Fig. 7b) are  
347 different to the typical approach of using a zeotropic blend (hypothetical T-S sketch presented in Fig. 7c). This is so,

348 since the proposed blend is a pressure swing blend, i.e. one in which the composition at which the azeotrope occurs  
349 changes with the pressure (property 8). Hence, for a fixed composition, different temperature glides are possible in  
350 different heat transfer equipment's, whereas a zeotropic fluid offers similar temperature glides in the evaporation and  
351 condensation processes, and usually do not include the considerations relating to the expansion VFR. Comparing the  
352 3 hypothetical T-S sketches, it can be concluded that the proposed blend can offer higher overall conversion efficiency  
353 when compared to the conventional pure fluid and zeotropic blend options. The justifications for the remaining  
354 screening parameters relevant to the present application are provided during the discussions in the following  
355 sub-sections.

## 357 4.2 Results and discussion

358 As a preliminary step to the detailed heat transfer equipment and expansion machine models, the following was  
359 considered for size and design intensity similarity between the pure fluid and its blend. It was assumed that,  $U$  was  
360 similar for the pure fluid and its blend. This assumption was made due to the high mass fraction of the original pure  
361 fluid (property 5), and screening of improved thermal conductivity (property 9) and specific heat values (property 10)  
362 for the blend constituent. Therefore,  $UA$  was considered equal for the pure fluid and its blend to act as an indicator of  
363 similar HEX, IHE and condenser sizes. Similarly, VFR defined as the ratio between the volumetric flow rates at the  
364 expansion outlet to inlet was also considered equal to act as an indicator of similar expansion machine size.

365  
366 Table 2 also summarises the system, size and design intensity, and performance parameters for T80 and MM80. For  
367 an equivalent heat transfer footprint and expansion machine size, T80 offered approximately 20% improvement in  
368 thermal efficiency (13.4 vs. 16.2%) and net power (14.8 vs. 18kW). This net power corresponded to a 5.7%  
369 improvement in the overall BTE from 41.4 to 43.8%. Similarly, MM80 offered approximately 25% improvement in  
370 thermal efficiency (11.1 vs. 13.9%) and net power (12.6 vs. 15.6kW). Contrary to the pure fluids, the blends offered  
371 super atmospheric condensation pressures. This was so since, the formulated blends were homogeneous positive  
372 azeotropes and their boiling points were lower than both of the blend constituents (property 8 and 11). As a result, the  
373 blends will demonstrate a lower sensitivity to the absolute pressure loss in any heat transfer element. This advantage  
374 bodes well for the use of inexpensive heat transfer equipment for the blends. Hence, the high boiling point of the  
375 higher thermal stability fluids was one of the reasons that drove the organic blend study.

376  
377 Figure 9a and b depicts the T-S diagram of toluene and T80 for comparison under an equivalent size and design  
378 intensity. T80 offered a 57 and 34°C temperature differences during evaporation and condensation processes,  
379 mirroring the high heat source temperature drop (251°C) and the low heat sink temperature rise (20°C), respectively.  
380 Similarly, MM is compared to MM80 in Fig. 9c and d, where MM80 offered a 29 and 15°C glides during evaporation

381 and condensation processes, respectively. In both cases, the pure fluid and its blend recovered nearly equal amounts  
382 of exhaust heat. However, the blends offered higher pressure (22.7 vs. 8.8; 16.9 vs. 7.5 bar) and temperature (182 vs.  
383 151; 141 vs. 128 °C) differentials in the cycle. In all the cases, the maximum working fluid temperature was below  
384 250 °C. To minimise the numerical error in the  $UA$  value for the blends the heat exchange was divided into 10 equal  
385 enthalpy intervals during the phase-change process.

386  
387 Both the blends allowed the continued use of the IHE, which is vital for reducing the size of the air cooled condenser.  
388 For the considered IHE, the pinch point for all the fluids occurred close to the low-temperature low-pressure vapour  
389 side and the high-pressure low-temperature liquid side. The IHE duty for toluene and T80 both corresponded to  
390 approximately 30% of the total heat input. However, the IHE duty for MM was higher at approximately 60%,  
391 compared to 45% for MM80. The IHE duty is a function of the ratio of latent heat to sensible heat, the level of  
392 superheat, the shape of the saturated vapour curve, the condensing temperature and the expansion efficiency. The  
393 IHE duty for MM80 was lower since the screening criteria avoided the formulation of extremely drying blends with low  
394 latent heat of vaporisation (property 1 and 12). The concept of internal heat recuperation is advantageous, however in  
395 reality, due to the nature of organic-vapour to organic-liquid heat exchange process, the heat transfer coefficients are  
396 relatively low. Hence, a trade-off exists even between the level of internal heat recuperation and size [17].

397  
398 A concern with blends offering significant glide (i.e. both pressure swing and zeotrope) in practical application is that  
399 under reduced source heat in the evaporator the lower boiling point fluid will boil and float to the top entering the  
400 expansion machine first. This may lead to the accumulation of the higher boiling point fluid, bringing challenges such  
401 as incomplete phase change (i.e. two-phase at the expansion machine inlet) and decreased heat transfer  
402 performance. Nevertheless, since the blends were formulated to recover high grade heat, this issue may be  
403 addressed by using a slightly superheated expansion, as simulated here, rather than dry saturated vapour expansion.  
404 A marginal superheat in the evaporator will ensure all the constituents are evaporated and the relative mass ratios are  
405 maintained.

#### 406 407 **4.3 Rational for the blend composition**

408 The 80% by mass concentration of toluene and MM were considered as near-optimal. Consider Fig. 10a, which  
409 compares the turbine size parameter ( $S_{exp}$ , m) and  $UA/kW$  value for varied toluene concentration as calculated using  
410 the below equations.

$$411 S_{exp} = \sqrt{\dot{V}_{exit} / \Delta h_{exp}^{0.25}} \dots (13)$$

$$412 UA/kW = (UA_{EXH} + UA_{IHE} + UA_{cond}) / \dot{W}_{net} \dots (14)$$

413 Where,  $\dot{V}$  is the volume flow rate ( $\text{m}^3/\text{s}$ ). The physical significance of  $S_{exp}$  and UA/kW values are given by the  
414 proportionality to the actual turbine dimensions and normalised overall heat transfer footprint, respectively [19, 45].  
415 The ORC was modelled utilising the assumptions in Table 1 and was targeted for an equal net power of 13kW by  
416 varying the cycle pressure.

417  
418 The 80% toluene concentration demonstrated the lowest UA/kW value (i.e. 23% lower than T20). For these  
419 concentrations, the variation in the turbine size was relatively low (i.e. 6% between T80 and T20). Furthermore,  
420 Fig. 10b compares the thermal efficiency for the varied toluene concentration. T80 demonstrated the highest thermal  
421 efficiency (i.e. 12% higher than T20). Contributing to the higher thermal efficiency was the efficient heat exchange in  
422 the IHE and around twice the temperature glide in the ideal evaporation process compared to the ideal condensation  
423 process (i.e. without pressure losses). Hence, when considering the turbine size parameter, UA/kW value and thermal  
424 efficiency, the 80% toluene concentration offered a preferred blend. The same was also true for the selection of 80%  
425 MM concentration. The higher concentration was additionally chosen to retain the advantages of higher molecular  
426 weight and higher thermal stability (property 5). A higher molecular weight bodes well for turbines as expansion  
427 machines. Since, a single method to reintroduce the recovered energy into the powertrain has not yet been identified  
428 by the HDDE sector, the use of T80 and MM80 may allow the continued examination of both radial turbines and piston  
429 expanders.

#### 431 **4.4 Fluid properties**

432 Table 4 presents the key fluid properties for comparison between the blends and their pure fluid counterparts. The  
433 values are presented for a low-temperature saturated-liquid condition and a high-temperature saturated-vapour  
434 condition. This offers an indication about the various fluid properties at the two possible extreme temperature,  
435 pressure and phase conditions that may be experienced in an ORC. At the low-temperature condition, the blends  
436 offered marginal improvements in thermal conductivity (5%) and specific heat (18%). Whereas, at the  
437 high-temperature condition, the specific heat values were nearly equal and the thermal conductivity was marginally  
438 higher for the blends (9%). As a first approximation, these results support the equivalent  $U$  assumption made in this  
439 study between the blend and its pure fluid counterpart. The pure fluid and blend properties were calculated using the  
440 Peng-Robinson and Wilson fluid property packages, respectively [46].

441  
442 Furthermore, due to the screening criteria employed (Table 3), the blends are expected to offer freezing temperatures  
443 (property 13), thermal decomposition temperatures (property 14), auto-ignition temperatures (property 15), National  
444 Fire Protection Association rating (property 16, 17 and 18) and environmental impact (property 19 and 20) comparable  
445 to the pure fluid counterparts, so as to retain their validity for the considered application [9, 17, 35, 47]. The blends are

446 additionally expected to offer the carryover of the currently developed ORC components for hydrocarbons and  
447 siloxanes. This is expected due to the molecular makeup (property 21) and a wide compatibility with common metals  
448 and alloys, O-ring materials and thermoplastic (property 22) as the additional screening criteria for the blend  
449 constituent [9, 48] .

## 451 **5 Economic analysis**

452 The current market niche for ORC systems is dependent on simplicity and affordability, with initial technology  
453 deployment on automotive HDDEs expected during the middle of the next decade. To estimate the potential cost  
454 savings when utilising the identified blends over their pure fluid counterparts, a detailed economic review and an  
455 original cost analysis study was conducted. In the detailed economic review, appropriate equations representing the  
456 conceptual equipment cost estimates were derived from references [6, 30, 39, 49-52]. Whereas, in the original cost  
457 analysis study, a significant volume of equipment cost and capability data was collected during a pre-procurement  
458 research phase from the north American and the European process industry supply chain. As a result of these two  
459 studies, purchase cost equations (in USD) for all the major ORC components were formulated, as presented in  
460 Table 5. These were under the assumptions of high volumes of production, direct exhaust heat utilisation and output  
461 capacities of 10-100kW. Applying the chemical engineering plant cost index, the equations were adjusted to the end  
462 of the year 2015. A further marginal adjustment was included to account for the cost and capability improvements due  
463 to the current technological advancements resulting from the findings of the original cost analysis study. However, the  
464 effect of this was limited to less than a 20% variation over the equations representing the conceptual equipment costs.  
465 Note that, these equations are corrected and must be utilised within the range of application stated.

466  
467 Such cost estimating methodologies are considered valuable in feasibility studies. By considering the key design and  
468 operational characteristics of a process, not only the competitive position may be assessed, but this may also aid in  
469 focussing the development efforts. These equations were based on the step count and exponential methods for  
470 order-of-magnitude estimates derived from commercial data. Although the actual cost of a particular equipment  
471 depends on multiple factors, nonetheless, cost functions can be linked to some key variables to provide estimates with  
472 errors as low as 10%. For the considered case, these variables included, materials of construction, operating  
473 conditions (i.e. pressure, temperature and phase) and parameters relating to the capacity (i.e. power, area and  
474 volumetric flow). Note that, for some processes, two suitable types of equipment's were available, and hence, two cost  
475 equations were considered. They were grouped as primary and secondary options, based on the number of  
476 dependent variables. To avoid over simplification, the primary options were typically a function of one additional  
477 variable compared to the secondary option. For example, the blends required higher pressures (10-15bar) than their  
478 pure fluid counterparts. Hence, the cost equations corresponding to the primary ORC option accounted for the



479 increased costs due to this variable. Whereas, in the secondary ORC option, the components had no cost variation  
480 under the considered pressure range.

481  
482 Table 6 presents the cost results for the blends and their pure fluid counterparts for the primary and secondary ORC  
483 options. The pipe length (7.5 m) and diameter (0.015 m), the tank capacity (30 L), and the expansion machine bypass  
484 valve diameter (0.015 m) were considered equal for all the fluids. Furthermore, the control and instrumentation (\$900),  
485 and the unaccounted hardware costs (\$900) were also considered equal. For ORCs under the considered application,  
486 these five items accounted only 0.5-2.5% each of the total system cost. Therefore, the above fixed cost assumptions  
487 should give sufficient accuracy, since their impact on the overall cost variation between the different fluids will be  
488 marginal. The quotations for the identified blends and their pure fluid counterparts were sourced from two different  
489 suppliers each, for quantities representing near economies-of-scale (Sigma Aldrich, Fisher Scientific, Spectrum  
490 Chemical, TCI Chemical). The resulting fluid costs were 5.1, 6.8, 7.5 and 10.8\$/L for toluene, MM80, MM and T80,  
491 respectively. A fixed 30 L fluid cost was added for each of the ORC options.

492  
493 To estimate the required area for the HEX, the IHE and the condenser, mean  $U$  values were considered for exhaust to  
494 evaporating-hydrocarbons ( $65\text{W/m}^2\text{°C}$ ), vapour-hydrocarbons to liquid-hydrocarbons ( $200\text{W/m}^2\text{°C}$ ) and air to  
495 condensing-hydrocarbons ( $475\text{W/m}^2\text{°C}$ ) from references [5, 51-53], respectively. The same set of values were utilised  
496 for both the blends and their pure fluid counterparts. These values are only meant to act as a reference for  
497 comparison between the pure fluid and its blend (e.g. Toluene vs. T80) due to the comparable heat transfer properties  
498 (Table 4). They are not suggested for comparing two noticeably different fluids (e.g. Toluene vs. MM), which may  
499 require detailed heat transfer equipment design.

500  
501 From table 6, it can be noted that on average, the turbine-generator unit had the highest proportional cost (45%),  
502 followed by the air cooled condenser (25%) and finally by the exhaust HEX (12%). The cost of the air cooled  
503 condenser included the cost of an additional fan and motor, while the exhaust HEX costs were based on evaporator  
504 type HEXs for direct high-temperature exhaust heat utilisation. The pump and IHE costs were relatively similar at 5%  
505 each. The thermodynamic and economic optimisation study by Le et al. has also indicated the highest proportional  
506 cost (approximately 40%) due to the turbine-generator unit [39]. As a result, in exhaust heat recovery applications,  
507 which correspond to high-temperature differentials between the heat source and the heat sink, the requirement of  
508 cost-effective and efficient piston expanders with high VFRs remains a vital development direction.

509  
510 The total absolute ORC costs when utilising the identified blends were marginally higher (2-3%) compared to their  
511 pure fluid counterparts. Fig. 11a shows the marginally higher absolute cost for the T80 cycle when compared to the

512 toluene cycle for the primary option. This was principally due to the turbine-generator (5% due to higher capacity), the  
513 exhaust HEX (3% due to higher pressure) and the pump (13% due to higher pressure) costs. Similarly, Fig. 11c  
514 shows the marginally higher absolute cost for the T80 cycle when compared to the toluene cycle for the secondary  
515 option. In the secondary ORC option, the pump and the exhaust HEX costs were not a function of the variation in the  
516 demonstrated range of pressure. As a result, the cost of the turbine-generator increased (5% due to higher capacity),  
517 however, the exhaust HEX costs were equal, while the pump cost decreased (7% due to lower volumetric flow).

518  
519 To estimate the relative techno-economical trade-off between the blends and their pure fluid counterparts, the total  
520 system cost per unit of net power (\$/kW) value was considered. A relative comparison between ORCs will be more  
521 accurate when comparable working fluids (molecular make-up, property 21) under similar operating conditions (slightly  
522 superheated subcritical operation, Table 2) are considered. Furthermore, the blends offered marginal improvements in  
523 the expansion exit density (10-50%, Table 2), which additionally support the assumptions in the cost analysis [49]. As  
524 shown in Table 2, the blends demonstrated 22-24% higher net power. Therefore, when considering the \$/kW value as  
525 a measure, the blends demonstrated a 15-18% improvement. Fig. 11b shows a 15% reduction in the \$/kW value for  
526 the T80 cycle when compared to the primary toluene cycle option. Note that the secondary ORC option utilised pump,  
527 exhaust HEX and IHE that were approximately 50% lower in cost compared to the primary ORC option (i.e. nearly  
528 \$4750 in total). As a result, the secondary T80 cycle option presented the lowest \$/kW value of 1792. This was 16%  
529 lower than that demonstrated by the secondary toluene cycle option (Fig. 11d).

530  
531 It is important to highlight that since the resulting absolute component costs were derived from the process industries,  
532 they may not represent the true cost that can be demonstrated by the automotive sector. Preliminary and confidential  
533 cost data available from automotive consortiums indicated that the absolute cost of some of the prototype components  
534 may be up to 50% lower than those presented here [9, 54]. This is principally due to the synergies with the current  
535 automotive components, for example, adapting exhaust gas recirculation coolers to exhaust HEXs and turbocharges  
536 to turbines. Nonetheless, the analysis presented here is valuable in evaluating the relative cost variation amongst the  
537 options. Finally, despite the increased design intensity and cost of high-temperature ORCs (>400°C), the \$/kW values  
538 of the chosen blends under the primary option agree within a range of 10-20% when compared to the low-temperature  
539 ORCs studies (<200°C) using hydrocarbons (e.g. n-butane and n-pentane) from the literature [39, 49].

540  
541 Note that, parameters like the net power per unit of heat transfer area may not be a suitable indicator for the relative  
542 cost comparison in the considered application and capacity range [12, 45]. This is so since, heat transfer costs  
543 typically accounted for only 40% of the overall system cost. Net power per unit of heat transfer area may be better

544 suited to larger scale ORC units for lower grade heat recovery where the heat exchanger sizes and costs can be a  
545 dominant factor.

## 547 **6 Conclusion**

548 The use of toluene and MM as working fluids in high-temperature ORCs appears to be the preferred approach in the  
549 literature. However, these conventional ORCs are not reaching the required fuel savings within the expected costs for  
550 automotive applications. To facilitate the introduction of ORCs, an innovative approach has been presented in this  
551 paper. The concept aims to offer an efficient thermal match to the source and sink streams, increase the system  
552 temperature and pressure differentials, and decrease the sensitivity to system pressure losses. These advantages  
553 were achieved by adapting the fluid makeup using novel blends based on the developed 22 criteria screening  
554 methodology. Blends were formulated with toluene and MM as the significant component, so as to retain higher  
555 thermal stability, high molecular weight, low environmental impact and efficient use of an IHE. Two blends, one  
556 containing 80% toluene by mass (T80) and the other containing 80% MM by mass (MM80) were identified as  
557 near-optimum. These blends offered varying levels of temperature glides in the exhaust HEX and the air condenser to  
558 address the irreversibility losses due to isothermal phase-change at subcritical pressures. The blends also offered  
559 higher density at the minimum cycle pressure with reduced mass flow rate to increase the system temperature and  
560 pressure differentials for fixed expansion volume flow ratios.

561  
562 Simulations conducted for an equivalent heat transfer footprint (approximated as  $UA$ ) and expansion machine size  
563 (approximated as  $VFR$ ) amongst the blends and their pure fluid counterparts demonstrated a 20-25% improvement in  
564 thermal efficiency and net power. As a result, the proposed ORC approach utilising the blends presented the  
565 advantage of 15-18% lower \$/kW value compared to the pure fluid counterparts, thus improving commercialisation  
566 potential. The economic analysis was based on the step count and exponential methods for order-of-magnitude  
567 estimates derived from the latest commercial data. Under realistic boundary conditions and assumptions for  
568 automotive HDDEs, a maximum of 5.7% improvement in the overall engine BTE was achieved, with the most  
569 competitive ORC option costing 1792 \$/kW.

570  
571 The higher energy-density and cost-effective ORC approach presented in this paper was investigated using a  
572 simulation tool (Aspen HYSYS V8). Limited but crucial parameters were selected to offer a first basis for comparison.  
573 Additionally, appropriate equation-of-state was utilised to determine the blend characteristics. To address the  
574 limitations of this study, future works will focus on detailed heat exchanger and expansion machine models, followed  
575 by experimental results. Furthermore, since the charge air cooling has become a significant load on the modern  
576 engine cooling module, integration of this heat source will be investigated for transient conditions.

577

## 578 **Acknowledgements**

579 The author would like to acknowledge the support of Daniel Coren and the Advanced Engineering Centre with respect  
580 to proof-reading and provision of software tools, respectively.

581

## 582 **Reference**

583 [1] T. Wang, Y. Zhang, Z. Peng, G. Shu, A review of researches on thermal exhaust heat recovery with Rankine cycle,  
584 *Renewable and Sustainable Energy Reviews*, 15 (2011) 2862-2871.

585 [2] C. Sprouse III, C. Depcik, Review of organic Rankine cycles for internal combustion engine exhaust waste heat  
586 recovery, *Appl Therm Eng*, 51 (2013) 711-722.

587 [3] S. Edwards, J. Eitel, E. Pantow, P. Geskes, R. Lutz, J. Tepas, Waste Heat Recovery: The Next Challenge for  
588 Commercial Vehicle Thermomanagement, *SAE Int. J. Commer. Veh.*, 5 (2012) 395-406.

589 [4] D.W. Stanton, Systematic Development of Highly Efficient and Clean Engines to Meet Future Commercial Vehicle  
590 Greenhouse Gas Regulations, *SAE Int. J. Engines*, 6 (2013) 1395-1480.

591 [5] A. Domingues, H. Santos, M. Costa, Analysis of vehicle exhaust waste heat recovery potential using a Rankine  
592 cycle, *Energy*, 49 (2013) 71-85.

593 [6] A.S. Nafey, M.A. Sharaf, Combined solar organic Rankine cycle with reverse osmosis desalination process:  
594 Energy, exergy, and cost evaluations, *Renew Energ*, 35 (2010) 2571-2580.

595 [7] M. He, X. Zhang, K. Zeng, K. Gao, A combined thermodynamic cycle used for waste heat recovery of internal  
596 combustion engine, *Energy*, 36 (2011) 6821-6829.

597 [8] H. Chen, D.Y. Goswami, E.K. Stefanakos, A review of thermodynamic cycles and working fluids for the conversion  
598 of low-grade heat, *Renewable and Sustainable Energy Reviews*, 14 (2010) 3059-3067.

599 [9] A. Panesar, Waste Heat Recovery Using Fluid Bottoming Cycles For Heavy Duty Diesel Engines, PhD. thesis.  
600 School of Computing, Engineering and Mathematics, University of Brighton, DOI: 10.13140/RG.2.1.4559.0248, 2015.

601 [10] B.F. Tchanche, G. Lambrinos, A. Frangoudakis, G. Papadakis, Low-grade heat conversion into power using  
602 organic Rankine cycles - A review of various applications, *Renewable and Sustainable Energy Reviews*, 15 (2011)  
603 3963-3979.

604 [11] U. Larsen, L. Pierobon, F. Haglind, C. Gabriellii, Design and optimisation of organic Rankine cycles for waste heat  
605 recovery in marine applications using the principles of natural selection, *Energy*, 55 (2013) 803-812.

606 [12] F. Yang, H. Zhang, C. Bei, S. Song, E. Wang, Parametric optimization and performance analysis of ORC (organic  
607 Rankine cycle) for diesel engine waste heat recovery with a fin-and-tube evaporator, *Energy*, 91 (2015) 128-141.

608 [13] Z. Dimitrova, P. Lourdais, F. Maréchal, Performance and economic optimization of an organic rankine cycle for a  
609 gasoline hybrid pneumatic powertrain, *Energy*, 86 (2015) 574-588.

- 610 [14] S. Lecompte, H. Huisseune, M. van den Broek, M. De Paepe, Methodical thermodynamic analysis and regression  
611 models of organic Rankine cycle architectures for waste heat recovery, *Energy*, 87 (2015) 60-76.
- 612 [15] M. Imran, B.-S. Park, H.-J. Kim, D.-H. Lee, M. Usman, Economic assessment of greenhouse gas reduction  
613 through low-grade waste heat recovery using organic Rankine cycle (ORC), *Journal of Mechanical Science and*  
614 *Technology*, 29 (2015) 835-843.
- 615 [16] M.-H. Yang, R.-H. Yeh, Thermodynamic and economic performances optimization of an organic Rankine cycle  
616 system utilizing exhaust gas of a large marine diesel engine, *Appl Energ*, 149 (2015) 1-12.
- 617 [17] F.J. Fernández, M.M. Prieto, I. Suárez, Thermodynamic analysis of high-temperature regenerative organic  
618 Rankine cycles using siloxanes as working fluids, *Energy*, 36 (2011) 5239-5249.
- 619 [18] D. Seher, T. Lengenfelder, J. Gerhardt, N. Eisenmenger, M. Hackner, I. Krinn, Waste Heat Recovery for  
620 Commercial Vehicles with a Rankine Process, 21st Aachen Colloquium Automobile and Engine Technology, October  
621 8-12, Aachen, Germany, 2012.
- 622 [19] D. Maraver, S. Quoilin, J. Royo, Optimization of Biomass-Fuelled Combined Cooling, Heating and Power (CCHP)  
623 Systems Integrated with Subcritical or Transcritical Organic Rankine Cycles (ORCs), *Entropy*, 16 (2014) 2433-2453.
- 624 [20] Y.-Q. Zhang, Y.-T. Wu, G.-D. Xia, C.-F. Ma, W.-N. Ji, S.-W. Liu, K. Yang, F.-B. Yang, Development and  
625 experimental study on organic Rankine cycle system with single-screw expander for waste heat recovery from  
626 exhaust of diesel engine, *Energy*, 77 (2014) 499-508.
- 627 [21] H. Wang, R. Peterson, K. Harada, E. Miller, R. Ingram-Goble, L. Fisher, J. Yih, C. Ward, Performance of a  
628 combined organic Rankine cycle and vapor compression cycle for heat activated cooling, *Energy*, 36 (2011) 447-458.
- 629 [22] A. Yılmaz, Transcritical organic Rankine vapor compression refrigeration system for intercity bus air-conditioning  
630 using engine exhaust heat, *Energy*, 82 (2015) 1047-1056.
- 631 [23] G. Shu, J. Zhao, H. Tian, X. Liang, H. Wei, Parametric and exergetic analysis of waste heat recovery system  
632 based on thermoelectric generator and organic rankine cycle utilizing R123, *Energy*, 45 (2012) 806-816.
- 633 [24] G. Yu, G. Shu, H. Tian, H. Wei, L. Liu, Simulation and thermodynamic analysis of a bottoming Organic Rankine  
634 Cycle (ORC) of diesel engine (DE), *Energy*, 51 (2013) 281-290.
- 635 [25] E.H. Wang, H.G. Zhang, Y. Zhao, B.Y. Fan, Y.T. Wu, Q.H. Mu, Performance analysis of a novel system  
636 combining a dual loop organic Rankine cycle (ORC) with a gasoline engine, *Energy*, 43 (2012) 385-395.
- 637 [26] C. Yue, D. Han, W. Pu, Analysis of the integrated characteristics of the CPS (combined power system) of a  
638 bottoming organic Rankine cycle and a diesel engine, *Energy*, 72 (2014) 739-751.
- 639 [27] A.S. Panesar, R.E. Morgan, N.D. Miché, M.R. Heikal, Working fluid selection for a subcritical bottoming cycle  
640 applied to a high exhaust gas recirculation engine, *Energy*, 60 (2013) 388-400.
- 641 [28] Aspen Technology Software, HYSYS version 8, 2015.
- 642 [29] Ricardo Software, WAVE version 8.1, 2015.

643 [30] D. Meinel, C. Wieland, H. Spliethoff, Economic comparison of ORC (Organic Rankine cycle) processes at  
644 different scales, *Energy*, 74 (2014) 694-706.

645 [31] P.J. Mago, L.M. Chamra, K. Srinivasan, C. Somayaji, An examination of regenerative organic Rankine cycles  
646 using dry fluids, *Appl Therm Eng*, 28 (2008) 998-1007.

647 [32] European Parliament, Directive 2006/40/EC of the European Parliament relating to emissions from air  
648 conditioning systems in motor vehicles.

649 [33] Underwriters Laboratories, White Paper: Revisiting Flammable Refrigerants, 2011.

650 [34] G.Q. Shu, G. Yu, H. tian, H. Wei, X. Liang, Simulations of a Bottoming Organic Rankine Cycle (ORC) Driven by  
651 Waste Heat in a Diesel Engine (DE), SAE International, 10.4271/2013-01-0851, 2013.

652 [35] J.M. Calm, G.C. Hourahan, Physical, Safety, and Environmental Data Summary for Current and Alternative  
653 Refrigerants, International Congress of Refrigeration, August 21-26, Prague, Czech Republic, 2011.

654 [36] M.A. Siddiqi, B. Atakan, Alkanes as fluids in Rankine cycles in comparison to water, benzene and toluene,  
655 *Energy*, 45 (2012) 256-263.

656 [37] G. Latz, S. Andersson, K. Munch, Selecting an Expansion Machine for Vehicle Waste-Heat Recovery Systems  
657 Based on the Rankine Cycle, SAE International, 10.4271/2013-01-0552, 2013.

658 [38] H. Teng, G. Regner, C. Cowland, Achieving High Engine Efficiency for Heavy-Duty Diesel Engines by Waste Heat  
659 Recovery Using Supercritical Organic-Fluid Rankine Cycle, SAE International, 10.4271/2006-01-3522, 2006.

660 [39] V.L. Le, A. Kheiri, M. Feidt, S. Pelloux-Prayer, Thermodynamic and economic optimizations of a waste heat to  
661 power plant driven by a subcritical ORC (Organic Rankine Cycle) using pure or zeotropic working fluid, *Energy*, 78  
662 (2014) 622-638.

663 [40] DDBST, Online Dortmund Data Bank Search, [ddbst.com/ddb-search.html](http://ddbst.com/ddb-search.html), Accessed on 07.07.2015.

664 [41] L.H. Horsley, Azeotropic Data-III, Volume 3, American Chemical Society, ISBN 9780841205338, 1973.

665 [42] D.R. Lide, H.V. Kehiaian, CRC Handbook of Thermophysical and Thermochemical Data, Volume 1, Taylor &  
666 Francis, ISBN 9780849301971, 1994.

667 [43] Y. Feng, T. Hung, K. Greg, Y. Zhang, B. Li, J. Yang, Thermo-economic comparison between pure and mixture  
668 working fluids of organic Rankine cycles (ORCs) for low temperature waste heat recovery, *Energ Convers Manage*,  
669 106 (2015) 859-872.

670 [44] CHERIC, Binary Vapor-Liquid Equilibrium Data, [cheric.org/research/kdb](http://cheric.org/research/kdb), Accessed on 07.07.2015.

671 [45] H. Tian, G. Shu, H. Wei, X. Liang, L. Liu, Fluids and parameters optimization for the organic Rankine cycles  
672 (ORCs) used in exhaust heat recovery of Internal Combustion Engine (ICE), *Energy*, 47 (2012) 125-136.

673 [46] Aspen HYSYS V8, Physical Property Methods, 2015.

674 [47] R. Chacartegui, D. Sánchez, J.M. Muñoz, T. Sánchez, Alternative ORC bottoming cycles FOR combined cycle  
675 power plants, *Appl Energ*, 86 (2009) 2162-2170.

676 [48] J.M. Calm, Air-Conditioning and Refrigeration Technology Institute Refrigerant Database, Data Summaries:  
677 Volume 1, 2, 3: Single-compound Refrigerants, Zeotropes and Azeotropes, Toxicity and Compatibility  
678 (DOE/CE/23810-105,106,107), Virginia, U.S, 1999.

679 [49] S. Quoilin, S. Declaye, B.F. Tchanche, V. Lemort, Thermo-economic optimization of waste heat recovery Organic  
680 Rankine Cycles, Appl Therm Eng, 31 (2011) 2885-2893.

681 [50] R.K. Sinnott, Chemical Engineering Design: Chemical Engineering, Volume 6, Elsevier Science, ISBN  
682 9780080492551, 2005.

683 [51] R.H. Perry, D.W. Green, Perry's Chemical Engineers' Handbook, McGraw-Hill, ISBN 0070498415, 2007.

684 [52] M. Peters, K. Timmerhaus, R. West, Plant Design and Economics for Chemical Engineers, McGraw-Hill  
685 Education, 2003.

686 [53] T. Lestina, R.W. Serth, Process Heat Transfer: Principles, Applications and Rules of Thumb, Elsevier Science,  
687 ISBN 9780080544410, 2010.

688 [54] C. Cooper, F. Kamakate, T. Reinhart, M. Kromer, R. Wilson, Reducing Heavy-Duty Long Haul Combination Truck  
689 Fuel Consumption and CO2 Emissions, NESCCAF, ICCT, SwRI, TIAX, LLC., 2009.

690

691

692

693

694

695

696

697

698

699

700

701

702

703 Table 1 Engine performance, input variables for heat recovery analysis and ORC modelling assumptions

| HDDE performance    |         |      | ORC assumptions             |     |     |
|---------------------|---------|------|-----------------------------|-----|-----|
| Speed               | rpm     | 1440 | $\eta_{exp}$                | %   | 65  |
| $W_{engine}$        | kW      | 316  | $\eta_{pump}$               | %   | 55  |
| $\eta_{engine}$     | %       | 41.4 | $\Delta P_{heat\ transfer}$ | bar | 0.2 |
| ORC input variables |         |      | $T_{pp\ HEX}$               | °C  | 25  |
| $T_{exh}$           | °C      | 420  | $T_{superheat}$             | °C  | 5   |
| $c_{p\ exh}$        | kJ/kg°C | 1.15 | $T_{pp\ IHE}$               | °C  | 10  |
| $\dot{m}_{exh}$     | kg/s    | 0.4  | $T_{condensing}$            | °C  | 70  |
|                     |         |      | $T_{subcooling}$            | °C  | 5   |

704

705

706

707

708

709

710

711

712

713

714

715

716

717

718

719

720

721

722

723

724

725

726

727

728

729

730



731 Table 2 Key system, sizing and performance parameters for the conventional high-temperature fluids and their  
 732 proposed blends

|                                      |                   | Toluene | T80    | MM     | MM80   |
|--------------------------------------|-------------------|---------|--------|--------|--------|
| System parameters                    |                   |         |        |        |        |
| $P_{max}$                            | bar               | 9.1     | 23.8   | 7.9    | 17.9   |
| $P_{min}$                            | bar               | 0.3     | 1.1    | 0.4    | 1      |
| $T_{max}$                            | °C                | 216     | 243    | 193    | 207    |
| $T_{min}$                            | °C                | 65      | 61     | 65     | 66     |
| $T_{start\ of\ evaporation}$         | °C                | 212     | 180    | 189    | 173    |
| $T_{end\ of\ condensation}$          | °C                | 70      | 66     | 70     | 71     |
| $\Delta T_{evaporation\ (ideal)}$    | °C                | -       | 59     | -      | 30     |
| $\Delta T_{condensation\ (ideal)}$   | °C                | -       | 31     | -      | 11     |
| $\dot{m}_{fluid}$                    | kg/s              | 0.24    | 0.18   | 0.4    | 0.29   |
| $\dot{V}_{pump}$                     | m <sup>3</sup> /s | 2.9e-4  | 2.2e-4 | 6.3e-4 | 4e-4   |
| $\rho_{exp\ exit}$                   | kg/m <sup>3</sup> | 1.7     | 2.6    | 3.6    | 3.9    |
| $PR_{exp}$                           |                   | 13.1:1  | 15.8:1 | 9.6:1  | 12.9:1 |
| $\dot{Q}_{HEX}$                      | kW                | 110.2   | 111    | 113.3  | 112.1  |
| $\dot{Q}_{IHE}$                      | kW                | 30.4    | 33.8   | 64.3   | 50.2   |
| $\dot{Q}_{condenser}$                | kW                | 95.4    | 93     | 100.7  | 96.5   |
| $\dot{m}_{cooling\ air}$             | kg/s              | 4.8     | 4.6    | 5      | 4.8    |
| $\dot{W}_{exp}$                      | kW                | 15.2    | 18.9   | 13.4   | 16.8   |
| $\dot{W}_{pump}$                     | kW                | 0.5     | 0.9    | 0.9    | 1.2    |
| Size and design intensity parameters |                   |         |        |        |        |
| $UA_{HEX}$                           | W/°C              | 1560    | 1560   | 1390   | 1390   |
| $UA_{IHE}$                           | W/°C              | 1775    | 1775   | 4015   | 4015   |
| $UA_{condenser}$                     | W/°C              | 3320    | 3320   | 3820   | 3820   |
| $VFR_{exp}$                          |                   | 14:1    | 14:1   | 12:1   | 12:1   |
| Performance parameters               |                   |         |        |        |        |
| $\eta_{I\ ORC}$                      | %                 | 13.4    | 16.2   | 11.1   | 13.9   |
| $\dot{W}_{net\ ORC}$                 | kW                | 14.8    | 18     | 12.6   | 15.6   |

733

734

735

736

737

738

739

740

741

742

743

744

745

746

747

748

Table 3 Blend screening methodology consisting of 22 screening criteria to achieve the innovative ORC approach

| Property  | Toluene, MM                | Blend constituent  | Dual component blend                           |
|---|----------------------------|--|--|
| 1 Latent heat of vaporisation (at 100°C)        | 368, 193 kJ/kg             | ≥ 1.25X  |  |
| 2 Vapour density (at 100°C)                     | 2.2, 5.5 kg/m <sup>3</sup> | ≥ 1.25X  |  |
| 3 Condensation behaviour                        | Constant temperature       |  | Temperature glide is a function of composition |
| 4 Evaporation behaviour                         | Constant temperature       |  | Temperature glide is a function of pressure    |
| 5 Toluene and MM mass concentration             |                            |  | ≥ 66%  |
| 6 Available number of data sets                 |                            |  | > 10 (error less than 2°C)                     |
| 7 Market availability and industrial experience | Moderate to high           | Moderate to high   |  |
| 8 Fluid classification                          |                            |  | Homogeneous positive pressure swing azeotrope  |
| 9 Thermal conductivity (at 100°C)               | 0.114, 0.106 W/m°C         | ≥ 1.25X  |  |
| 10 Specific heat (at 100°C)                     | 1.9, 2.07 kJ/kg°C          | ≥ 1.25X  |  |
| 11 Boiling point                                | 111, 101°C                 | ≤ 100°C  |  |
| 12 Number of atoms in a molecule                | 15, 27                     | 6 to 15  |  |
| 13 Freezing temperature                         | -95, -59°C                 | ≤ -50°C  |  |
| 14 Thermal decomposition temperature            | > 308, > 300°C             | ≥ 250°C  |  |
| 15 Auto-ignition                                | 480, 340°C                 | ≥ 350°C  |  |
| 16 NFPA health rating                           | 2, 1                       | ≤ 2  |  |
| 17 NFPA flammability rating                     | 3, 3                       | ≤ 3  |  |
| 18 NFPA instability rating                      | 0, 0                       | 0  |  |
| 19 ODP  | < 0.00001                  | < 0.00001  |  |
| 20 GWP  | ≈ 20                       | ≤ 20   |  |
| 21 Molecular makeup                             | C, H, O (and Si)           | C, H, O (and Si)   |  |
| 22 Compatibility                                |                            | <ul style="list-style-type: none"> <li>▪ Metals and alloys (aluminum, carbon steel, cast iron, copper, stainless steel)</li> <li>▪ O-ring materials (ChemRaz, Kalrez)</li> <li>▪ Thermoplastic (PTFE)</li> </ul> |  |

749

750

751

752

753

754

755

756

757

758

759

760

761

762

763

764

765

766

767 Table 4 Key fluid properties for comparison between the blends and their pure fluid counterparts at the two possible  
 768 extreme fluid conditions in an ORC

|  | Toluene | T80   | MM    | MM80  |
|--|---------|-------|-------|-------|
| 70°C Saturated liquid                          |         |       |       |       |
| Molecular weight, $M_{wt}$ g/mol               | 92      | 67    | 162   | 108   |
| Pressure, $P_{saturation}$ bar                 | 0.3     | 1.2   | 0.4   | 0.9   |
| Density, $\rho_{liquid}$ kg/m <sup>3</sup>     | 822     | 831   | 712   | 735   |
| Specific heat, $c_p$ kJ/kg°C                   | 1.77    | 2.29  | 1.96  | 2.27  |
| Heat of vaporisation, $H_{vap}$ kJ/kg          | 383     | 557   | 206   | 344   |
| Thermal conductivity, $\lambda_{liquid}$ W/m°C | 0.121   | 0.129 | 0.115 | 0.121 |
| Viscosity, $\mu_{dynamic}$ cP                  | 0.352   | 0.341 | 0.3   | 0.381 |
| 170°C Saturated vapour                         |         |       |       |       |
| Pressure, $P_{saturation}$ bar                 | 4.1     | 7.1   | 5.3   | 9.7   |
| Density, $\rho_{vapour}$ kg/m <sup>3</sup>     | 11.2    | 12.9  | 29.4  | 28.4  |
| Specific heat, $c_p$ kJ/kg°C                   | 1.72    | 1.69  | 1.96  | 1.89  |
| Heat of vaporisation, $H_{vap}$ kJ/kg          | 324     | 527   | 151   | 311   |
| Thermal conductivity, $\lambda_{vapour}$ W/m°C | 0.025   | 0.027 | 0.023 | 0.026 |
| Viscosity, $\mu_{dynamic}$ cP                  | 0.01    | 0.012 | 0.011 | 0.011 |

769

770

771

772

773

774

775

776

777

778

779

780

781

782

783

784

785

786

787

788

789

790 Table 5 Equations representing the conceptual equipment cost estimates that were adjusted to the findings of the  
 791 original cost analysis study

| Equipment                             | Technology   | Dependent variable   | Purchase cost (\$)                                    | Material                                      | Range of application   |
|---------------------------------------|--|--|---|---|--|
| Working fluid pump (primary option)   | Reciprocating pump including motor   | Discharge volumetric flowrate ( $V_{pump\ exit}$ , m <sup>3</sup> /s) and discharge pressure ( $P_{pump\ exit}$ , kPa) | $(1544 + 0.237 P)^*$<br>$(0.633 + 667 V)$             | Carbon Steel                                  | 0.0001 to 0.001 m <sup>3</sup> /s<br>1035 to 5000 kPa  |
| Working fluid pump (secondary option) | Gear pump including gear transmission  | Discharge volumetric flowrate ( $V_{pump\ exit}$ , m <sup>3</sup> /s)  | $6348 V^{0.25}$                                       | Cast iron case, iron alloy gears, steel shaft | 0.0001 to 0.001 m <sup>3</sup> /s<br>Pressure $\leq$ 4140 kPa  |
| Condenser                             | Air cooled condenser including fan and motor                                   | Area ( $A_{cond}$ , m <sup>2</sup> ) and balance of the engine cooling module  | $3788 A^{0.42}$                                       | Carbon Steel                                  | Pressure $\leq$ 1035 kPa<br>Area $\leq$ 500 m <sup>2</sup><br>(area equivalent to bare tubes excluding fins) |
| IHE (primary option)                  | Welded plate heat exchanger  | Area ( $A_{IHE}$ , m <sup>2</sup> )  | $1926 + 28 A$   | Carbon Steel                                  | Pressure $\leq$ 1035 kPa<br>Area $\leq$ 500 m <sup>2</sup>   |
| IHE (secondary option)                | Gasketed plate heat exchanger  | Area ( $A_{IHE}$ , m <sup>2</sup> )  | $603 + 12.2 A$  | Carbon Steel                                  | Pressure $\leq$ 3000 kPa<br>Area $\leq$ 500 m <sup>2</sup>   |
| HEX (primary option)                  | Shell and fixed-tube heat exchangers (evaporator type for direct exhaust heat) | Area ( $A_{HEX}$ , m <sup>2</sup> ) and pressure ( $P_{HEX\ inlet}$ , kPa)   | $(2601 + 121 A - 0.25 A^2)^*$<br>$(0.00002 P + 0.95)$ | Carbon steel shell and tube                   | Shell $\leq$ 1035 kPa<br>Tube $\leq$ 5000 kPa<br>Area $\leq$ 100 m <sup>2</sup>                              |
| HEX (secondary option)                | Shell and plate heat exchanger (evaporator type for direct exhaust heat)       | Area ( $A_{HEX}$ , m <sup>2</sup> )  | $113 + 113 A$   | Carbon steel shell and plate                  | Pressure $\leq$ 4140 kPa<br>Area $\leq$ 100 m <sup>2</sup>   |
| Expansion machine                     | Radial turbine (gas and liquid type) including generator                       | Recovered power ( $W_{exp}$ , kW)  | $12664 + 197 W$                                       | Carbon Steel                                  | 10 to 100 kW   |
| Pipe                                  | Welded and screwed   | Diameter ( $D_{pipe}$ , m) and length ( $L_{pipe}$ , m)  | $82 L * (24 D + 0.08)$                                | Carbon Steel                                  | Diameter = 0.015 to 0.06 m<br>Length = 1 to 100 m  |
| Storage tank                          | Horizontal with round ends   | Volume ( $V_{tank}$ , L)   | $40 V^{0.58}$   | Carbon Steel                                  | 10 to 400 L  |
| Expansion machine bypass valve        | Pressure Reducing Valve (PRV)  | Diameter ( $D_{PRV}$ , m)  | $103 + 15035 D$                                       | Carbon Steel                                  | 0.01 to 0.1 m  |

792

793

794

795

796

797

798

799

800

801

802

803

804 Table 6 Absolute and specific costs for the primary and secondary ORC options utilising the blends and their pure fluid  
 805 counterparts

|                  | Fluid | Pipe | Tank | PRV | Controls and instrumentation | Additional hardware | Pump | IHE  | HEX  | Condenser | Turbine-generator | Total cost (\$) | Cost per net power (\$/kW) |
|------------------|-------|------|------|-----|------------------------------|---------------------|------|------|------|-----------|-------------------|-----------------|----------------------------|
| Primary options  |       |      |      |     |                              |                     |      |      |      |           |                   |                 |                            |
| Toluene          | 153   | 271  | 288  | 329 | 900                          | 900                 | 1454 | 2175 | 5191 | 8577      | 15658             | 35895           | 2434                       |
| T80              | 324   | 271  | 288  | 329 | 900                          | 900                 | 1644 | 2175 | 5348 | 8577      | 16387             | 37142           | 2061                       |
| MM               | 225   | 271  | 288  | 329 | 900                          | 900                 | 1832 | 2489 | 4902 | 9072      | 15324             | 36530           | 2906                       |
| MM80             | 204   | 271  | 288  | 329 | 900                          | 900                 | 1771 | 2489 | 5004 | 9072      | 15974             | 37200           | 2392                       |
| Secondary option |       |      |      |     |                              |                     |      |      |      |           |                   |                 |                            |
| Toluene          | 153   | 271  | 288  | 329 | 900                          | 900                 | 828  | 712  | 2825 | 8577      | 15658             | 31440           | 2132                       |
| T80              | 324   | 271  | 288  | 329 | 900                          | 900                 | 773  | 712  | 2825 | 8577      | 16387             | 32285           | 1792                       |
| MM               | 225   | 271  | 288  | 329 | 900                          | 900                 | 1006 | 848  | 2531 | 9072      | 15324             | 31692           | 2521                       |
| MM80             | 204   | 271  | 288  | 329 | 900                          | 900                 | 898  | 848  | 2531 | 9072      | 15974             | 32214           | 2072                       |

806

807

808

809

810

811

812

813

814

815

816

817

818

819

820

821

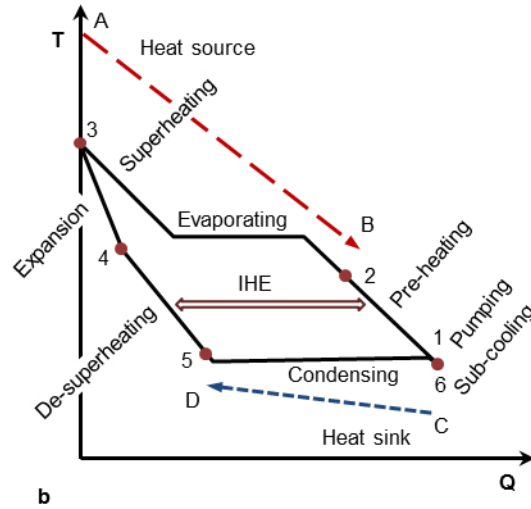
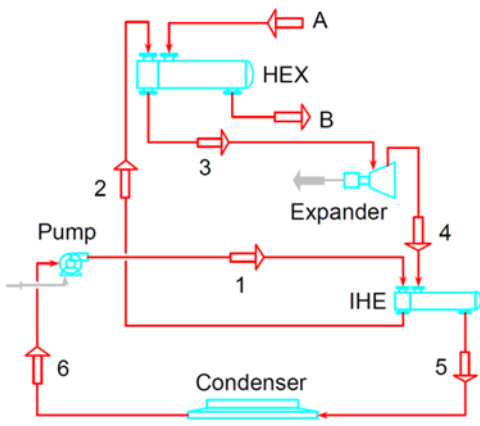

822 a

823 Figure 1 Considered ORC with an IHE (a) Simplified system schematic, and (b) T-Q sketch under superheated

824 subcritical operation

825

826

827

828

829

830

831

832

833

834

835

836

837

838

839

840

841

842

843

844

845

846

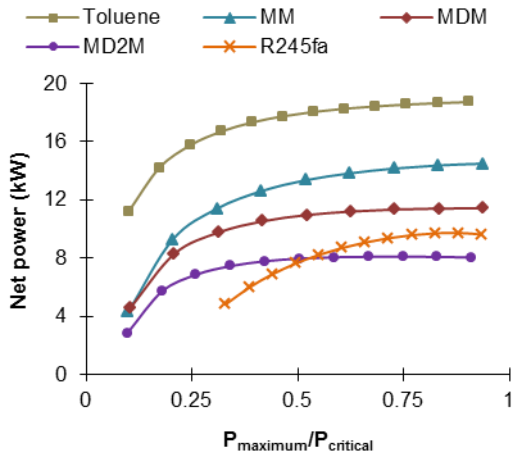

847

848 Figure 2 Net power comparison for the commonly suggested high-temperature fluids and R245fa on the bases of a  
 849 non-constrained expansion machine size

850

851

852

853

854

855

856

857

858

859

860

861

862

863

864

865

866

867

868

869

870

871

872

873

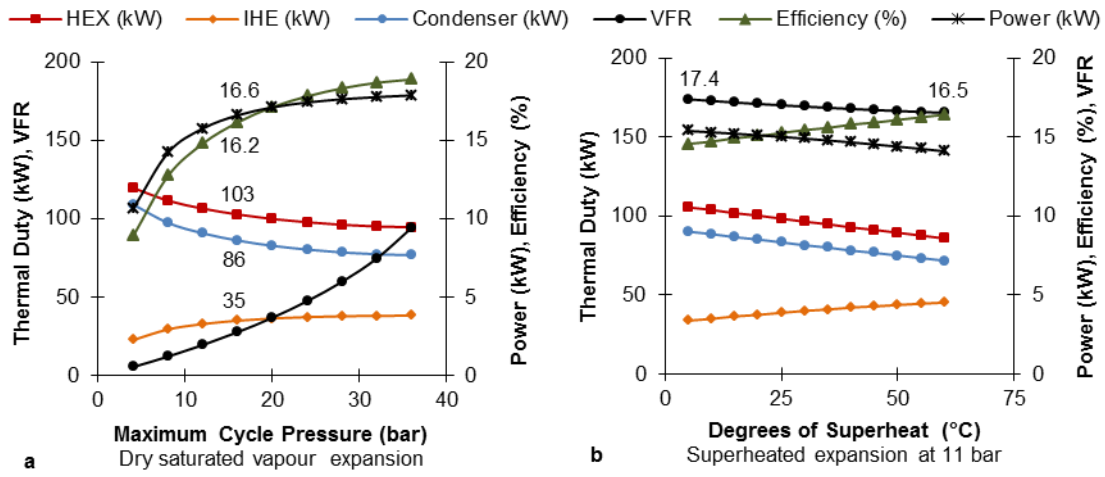

874

875

Figure 3 Effect on thermal duty and performance for toluene cycle by (a) Variation in cycle pressure, and (b) Variation

876

in cycle superheat

877

878

879

880

881

882

883

884

885

886

887

888

889

890

891

892

893

894

895

896

897

898

899



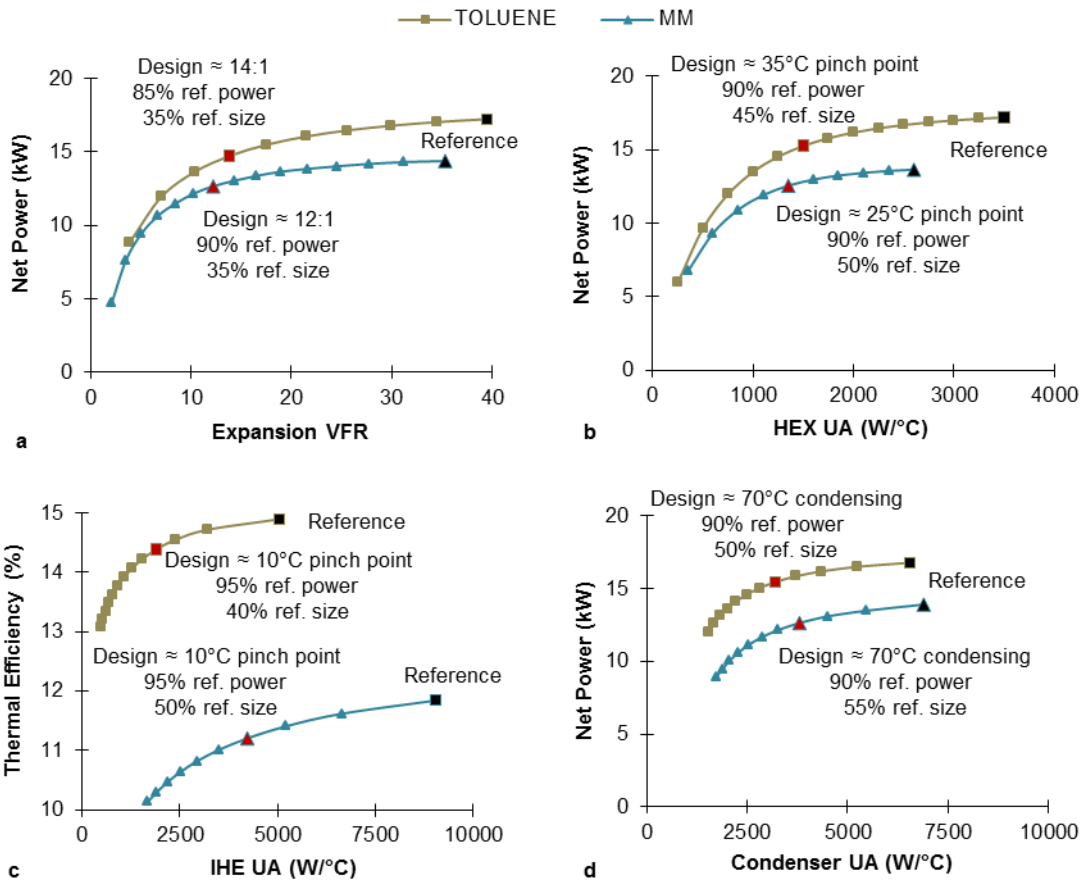
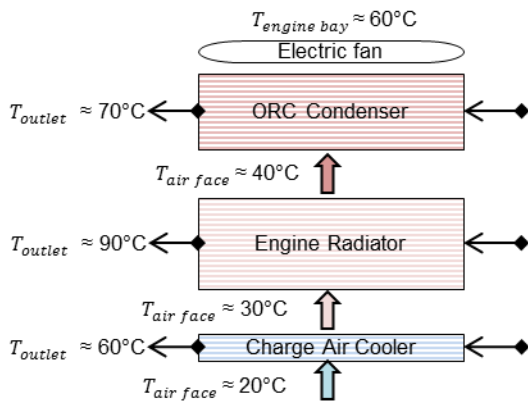

Figure 4 Equipment size and system performance trade-off for (a) Expansion machine, (b) Exhaust heat exchanger, (c) Internal heat exchanger, and (d) Air condenser



920

921

Figure 5 Schematic of the modified engine cooling module with an additional high-temperature condenser, showing

922

radiator/condenser outlet temperature as a function of air temperature rise through the module

923

924

925

926

927

928

929

930

931

932

933

934

935

936

937

938

939

940

941

942

943

944

945

946

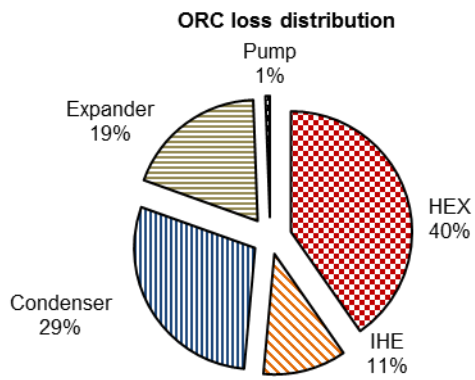

Figure 6 Irreversibility contributions by the toluene ORC processes at the design point condition

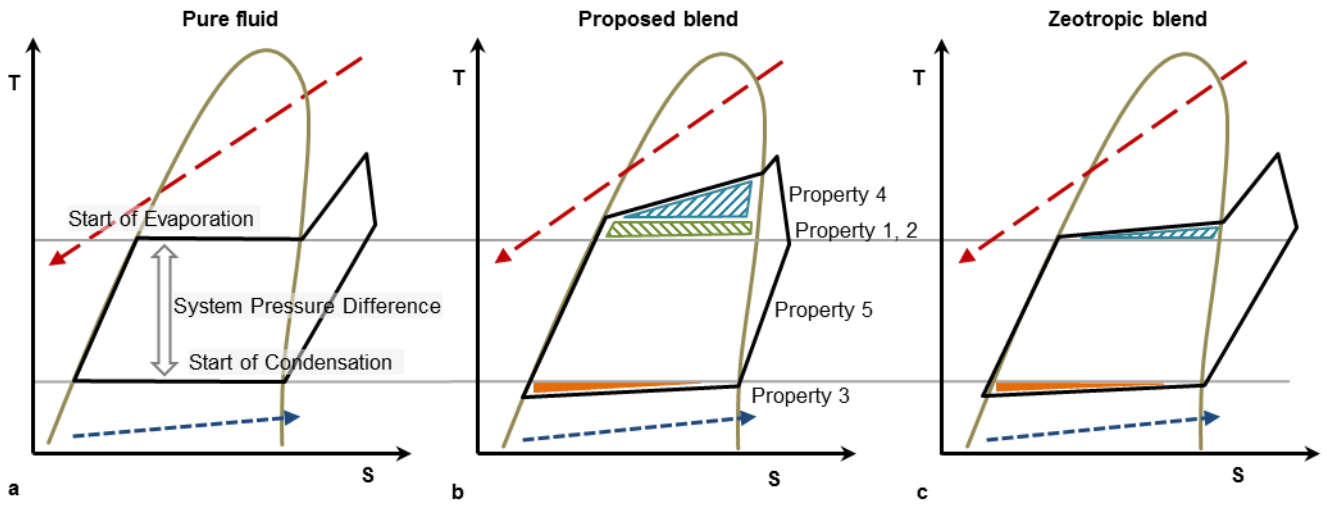
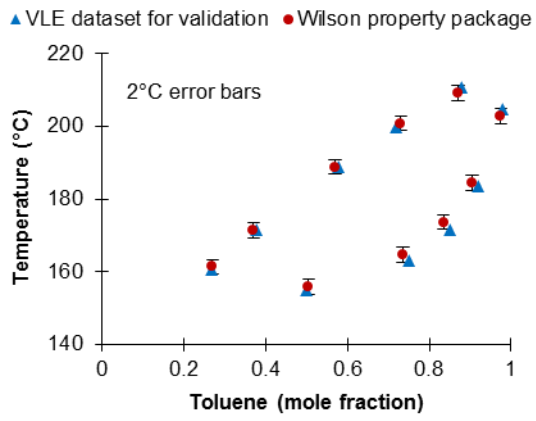

Figure 7 Comparing conceptual T-S diagrams and areas of loss reduction (a) Conventional ORC, (b) Proposed ORC, and (c) Conventional zeotropic ORC

975  
976  
977  
978  
979  
980  
981  
982  
983  
984  
985  
986  
987  
988  
989  
990  
991  
992  
993  
994  
995  
996  
997  
998  
999  
000



001

002

Figure 8 Validation of the VLE behaviour for the chosen fluid property package

003

004

005

006

007

008

009

010

011

012

013

014

015

016

017

018

019

020

021

022

023

024

025

026

027

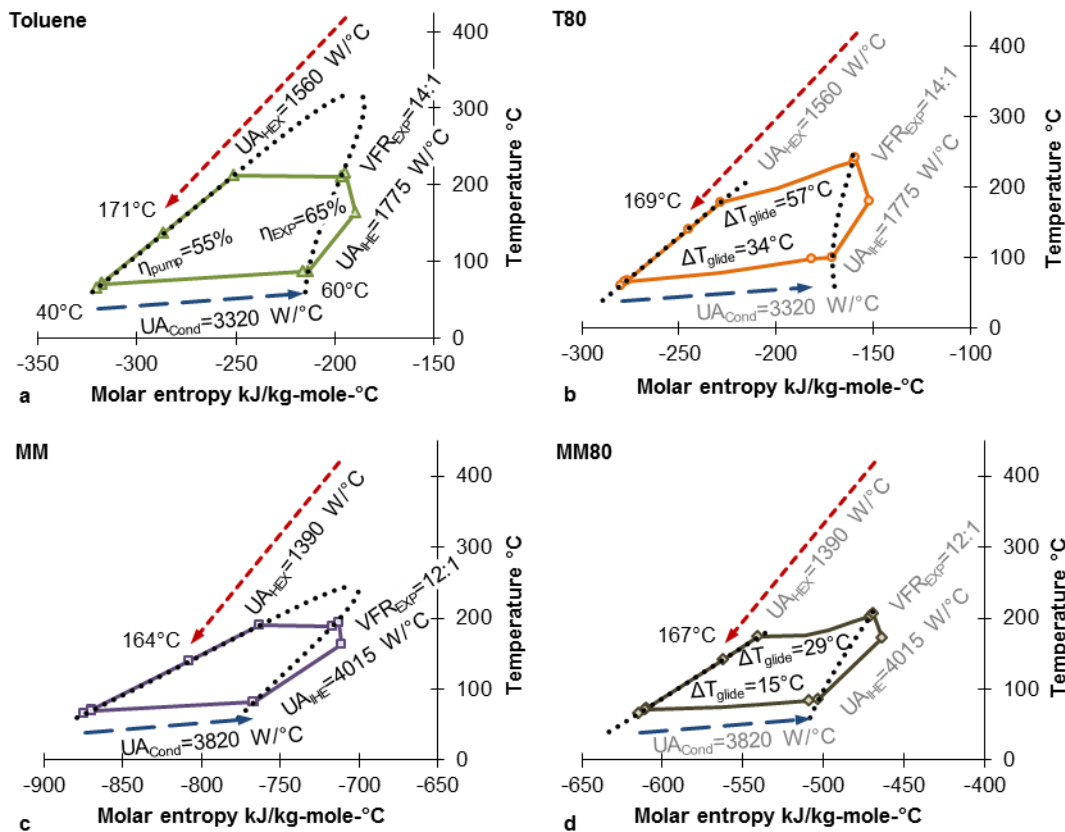

Figure 9 Comparing T-S diagrams under equivalent size and design intensity (a,b) Design point toluene vs. proposed T80, and (c,d) Design point MM vs. proposed MM80

028  
 029  
 030  
 031  
 032  
 033  
 034  
 035  
 036  
 037  
 038  
 039  
 040  
 041  
 042  
 043  
 044  
 045  
 046  
 047

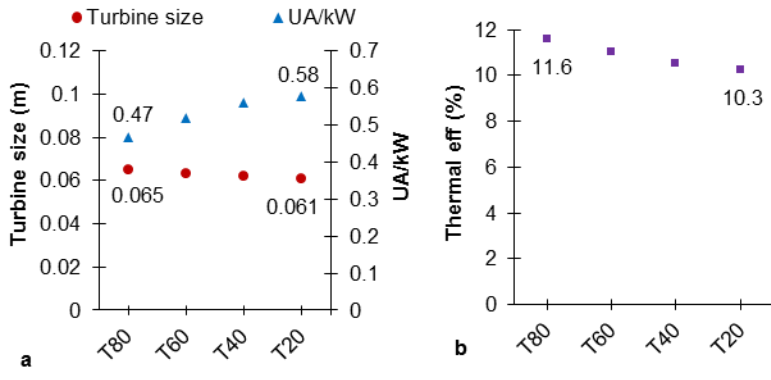
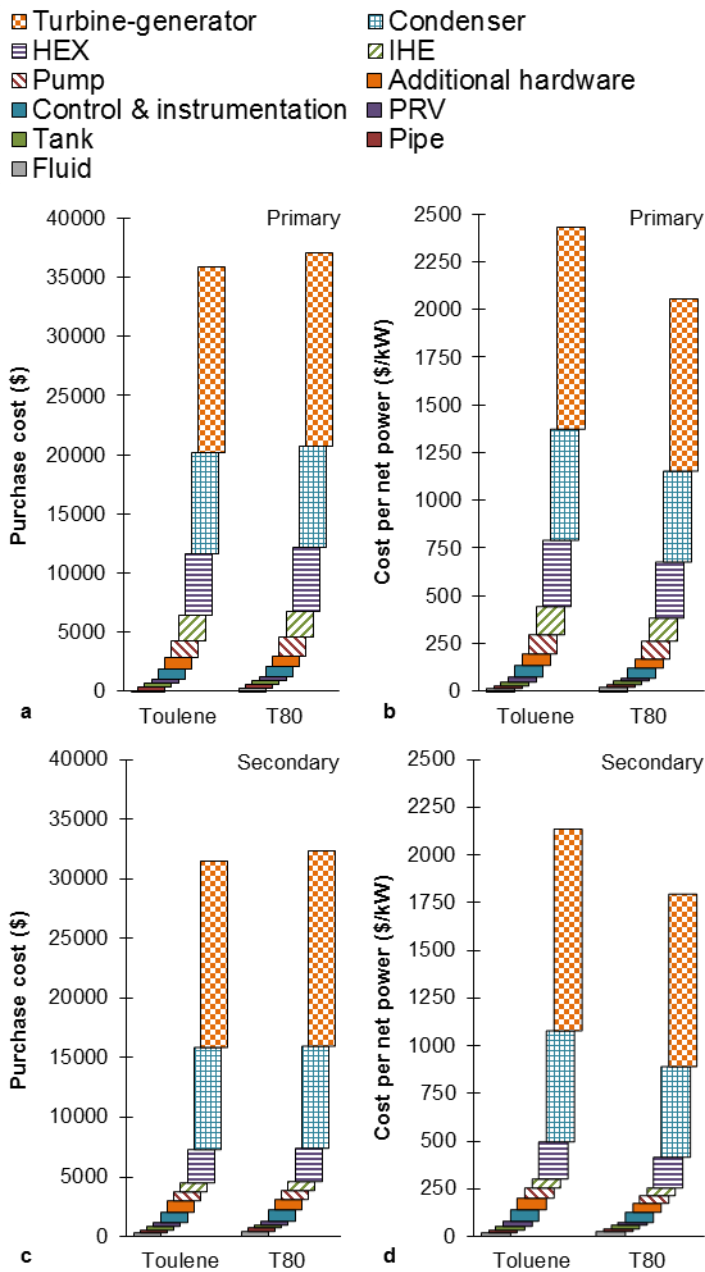

Figure 10 Effect of varied toluene concentration on (a) Turbine size parameter and normalised heat transfer footprint, and (b) Thermal efficiency



076

077

Figure 11 Comparison between toluene and T80 (a) Absolute costs for the primary option, (b) Specific costs for the

078

primary option, (c) Absolute costs for the secondary option, and (d) Specific costs for the secondary option