

Shadowgraphic Characterisation of Marine Lubricant Sprays

Tim Gardhouse^{*1}, Guillaume de Sercey¹, Cyril Crua¹, Simon Edwards², Céline Thompson²

¹Centre for Automotive Engineering, University of Brighton, UK

²BP Formulated Products Technology, Pangbourne, UK

*Corresponding author: t.gardhouse@brighton.ac.uk

Abstract

Spray behaviour of marine cylinder lubricant was investigated experimentally using high-speed shadowgraphic techniques. Through the use of an optical liner and optical nozzle, spray behaviour has been characterised in these regions: in-nozzle flow, near-nozzle and free spray breakup, and liner impingement. The effects of viscosity are prominently visible in each of these areas. Cavitation has been shown to play a key role in the lubricant injection system, with the spray splitting into two distinct sprays at low viscosities.

Introduction

Lubrication in large, low-speed marine engines (60-100 rpm, up to 80,000 kW) has traditionally been provided by a series of low-pressure quills introducing oil into a groove around the liner circumference. Vertical distribution is provided by the piston rings. The vertical scale of these engines (up to 3.5 m) means that in order to properly lubricate the top of the cylinder, there is a tendency to over-lubricate lower regions. Oil is delivered through the quills at a pressure of around 4 bar. This delivery pressure means that delivery of oil is dependent on the in-cylinder pressure for timing.

Newer systems use high pressure injectors to provide liner coverage in a more efficient and controlled manner by spraying lubricant across the cylinder directly to the liner [1-5]. These modern lubricant delivery systems use a higher delivery pressure (50 bar or more) to provide more flexibility in delivery timing. Lubricant can be delivered directly onto the piston rings, or timed to be delivered above the piston rings as engine conditions require. As a consequence of the higher delivery pressure, lubricant can be delivered in the form of a spray. As lubricant is delivered as a spray, this spray can be directed upward, aiding the vertical delivery in these large engines, reducing over-lubrication.

Newly introduced emissions regulations are driving innovation in marine engines. In particular, the heavy fuel oil in general use is being replaced with a lower-sulphur distillate fuel in designated emissions control areas and the practice of slow-steaming (running the engine at low speed for extended periods) is changing the operating conditions of these engines. With lubricant selection tied closely to the fuel in use, and with current lubricants optimised to traditional delivery methods, there is a need to understand how lubricant composition and properties affect the performance of these modern lubrication systems.

The system under study, representative of modern delivery systems, is the Hans Jensen SIP (Swirl Injection Principle) system which is described in greater detail in [1, 3]. It consists of a number of oil injector valves mounted slightly recessed within the cylinder liner and spaced evenly around its circumference. These injectors are connected to separate output ports of an electronically triggered hydraulic cylinder (called 'Lubtronic'). This hydraulic cylinder supplies high-pressure oil and the volume of oil supplied can be adjusted by modifying the stroke of the cylinder. Injection timing is controlled by this cylinder in combination with the opening pressure of an adjustable one-way valve within the injector. The injectors are designed to spray oil upwards and onto the cylinder liner out of a single 0.3 mm hole. This injection takes place during the upward stroke of the piston making use of the swirling scavenging air to help carry the oil droplets in a rotating pattern upward towards the combustion zone.

Experimental setup

In order to visualize the lubricant spray coming out of an injector, and its impact on the liner, an optical visualisation chamber was built. The injector was mounted on the side of this chamber and oriented so that the spray is parallel to the front of the box, at an angle of 30° to horizontal. The injector was housed in a heating jacket so that normal liner temperatures could be replicated. Furthermore, by varying the temperature of the heating jacket it was possible to modify the viscosity of the oil injected. A removable curved sheet of acrylic with an inner diameter of 0.96 m, matching that of a typical low-speed marine engine, was mounted inside the enclosure. The relative position of the injector and simulated liner section was identical to that on a real engine so that, excepting differences in material and lack of air

pressure and motion, the system was geometrically representative of in-engine spray conditions. Figure 1 shows a CAD model of the visualisation chamber with the injector, heating jacket and removable liner in place.

The high pressure lubricant was supplied by an off-the-shelf Hans Jensen Lubtronic hydraulic piston. In order to replicate the back-pressure effect that would come from the seven missing injectors, the seven unused outputs of the Lubtronic were connected to a manifold fitted with adjustable non-return valves. The Lubtronic was powered by a small power pack that provided 70 bar of hydraulic oil pressure. The lubricating oil was fed from a one litre tank regulated at 55 °C. The hydraulic and lubricating oil circuits were completely isolated to avoid any cross-contamination of the lubricants.

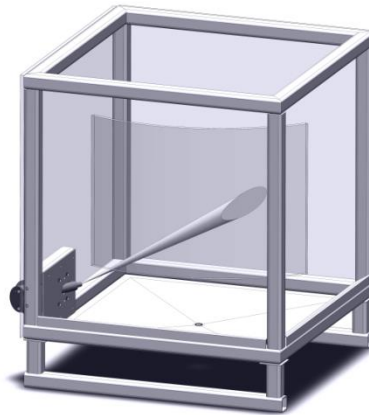

Figure 1. Injection chamber with optical liner.

High-speed video and optical system

The experimental setup for the high-speed imaging system is shown in Figure 2. The camera used was a Vision Research Phantom v12.1. Videos were recorded at a resolution of 1280 x 240 pixels at a frame rate of 20 frames per second. The camera was paired with a standard 80-200 mm lens for videos with a wider field of view, and a long-range microscope (Infinity model K-2) for higher magnification videos. The camera was mounted on a slanted traverse that replicates the vertical angle of the injector, so that the camera could easily be translated along the spray axis.

Illumination was provided by the diverging beam of a pulsed copper-vapour laser. Light was transmitted through a fibre optic and expanded before being passed through a large (455 mm diameter) Fresnel lens for collimation. The laser was synchronised to the camera, with one laser pulse per video frame. The duration of each pulse was 25 ns, ensuring that motion of the spray within a frame was less than a single pixel – eliminating motion blur.

The camera and laser were set up in a shadowgraphic configuration, either side of the spray chamber, so that the spray is visualised as dark in front of an illuminated background.

Videos were processed using custom MATLAB scripts to normalise backgrounds and to binarise for further processing as required. Further processing included coverage area on the optical liner, spray tip penetration and angle, and cavitation length inside the nozzle.

Temperatures in the lubricant tank, at the inlet and outlet of the Lubtronic and at the inlet of the injector were monitored with K type thermocouples. Oil pressure at the inlet of the injector was recorded with a Kistler 601A piezo-electric sensor. As this sensor measure dynamic changes in pressure, a Kistler 4262A also measured the absolute pressure at the outlet of the Lubtronic. Temperatures and pressures were recorded with a National Instruments real-time controller using a custom program written in-house. The real-time controller also provided simultaneous triggers for the injection and recording of the video. Synchronisation of the laser pulses with the camera was realised with a programmable pulse generator.

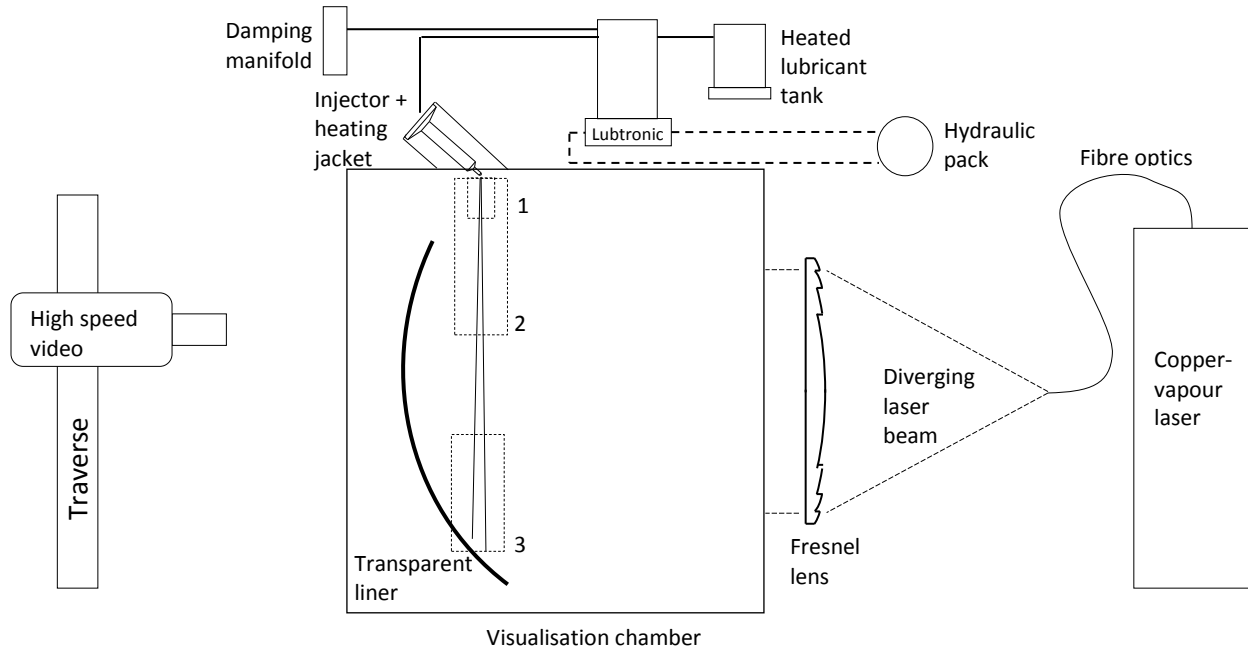

Figure 2. Optical and hydraulic setup.

Impact and spray visualisation

Tests were carried out on oils with a wide range of viscosities, base oil configurations, and additives. This paper presents results from two oil viscosities, presented here as ‘high’ and ‘low’. The behaviour of each oil was visualised at three different positions, marked with dashed rectangles in Figure 2: through an optical liner, the free spray, and a high-magnification view of the near-nozzle region. The bulk of the spray (rectangle 2) and the impact on the liner (rectangle 3) were visualised with the 200 mm lens, while the spray as it exits the injector nozzle (rectangle 1) was visualised with a much greater magnification using the long-range microscopic lens.

Viscosity was varied by changing the oil temperature. Although other oil properties vary with temperature (i.e. surface tension and density), these properties vary linearly with temperature whereas viscosity decreases exponentially. Thus viscosity is expected to be the dominant factor in the results presented here.

Figure 3a shows the liner coverage for the high viscosity and Figure 3b shows the coverage for the low viscosity. The impact of the oil is visualised through the liner and, since these images are shadowgraphs the oil appears dark. The lighter patches within the impact area do not indicate absence of oil but rather a different thickness of oil that rather than absorbing the light refracts it. The high viscosity oil produces a fairly uniform elliptical coverage area whilst the low viscosity oil provides two distinct coverage areas. Each of these coverage areas was smaller than the high viscosity impact and consisted of smaller droplets. In both cases, the coverage is less than seen by the manufacturer in their wind tunnel tests [3], most likely due to the lack of swirling air.

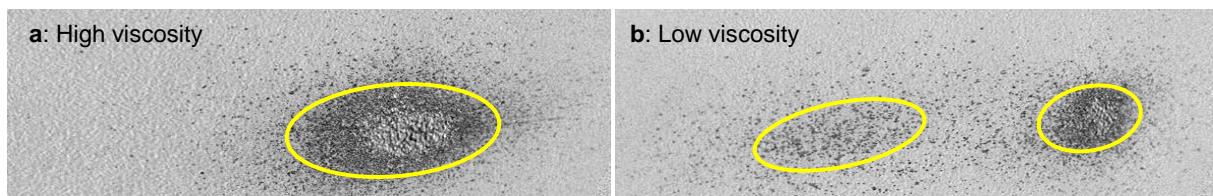

Figure 3. Liner impacts. a) High viscosity, single impact. b) Low viscosity, dual impact.

To understand the cause of the differences in coverage patterns, it was important to examine the processes happening before the impact, beginning with the spray itself.

Figure 4 shows the high viscosity oil spray at two different timings; one early timing where the spray is only 54 mm long and a later timing where the spray is fully evolved (162 mm) before it would impact the liner. For these images,

however, the liner has been removed from the visualisation box. Note that the rounded shape on the left edge of the images is the tip of the injector. Due to the high viscosity of the oil, the spray is more jet-like and shows little atomisation.

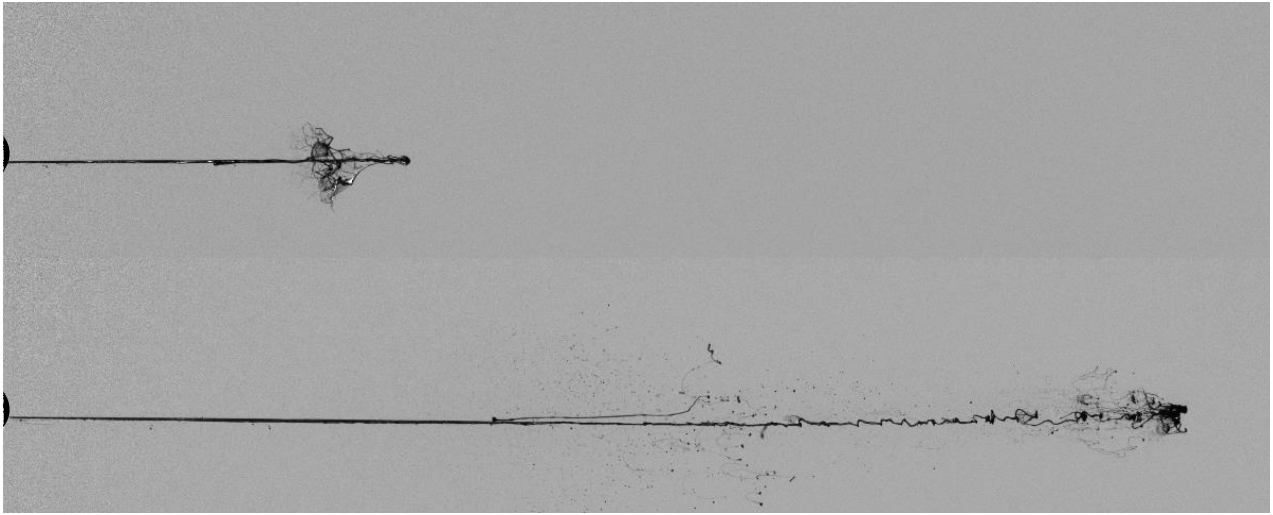

Figure 4. Spray evolution of a high viscosity oil

Figure 5 shows the low viscosity oil spray for the same spray length. The spray is now more atomised and thus traveling slower. More significantly, at the earlier timing, a secondary, slightly slower jet is present slightly below the main jet. This manifests itself as a secondary stream of droplets below the bulk of the spray at the later timing and explains the two separate coverage spots seen in Figure 3.



Figure 5. Spray evolution of a low viscosity oil

Finally, Figure 6a shows the near-nozzle spray of the high viscosity oil acquired with the long-range microscope whilst Figure 6b shows the low viscosity spray under the same conditions. The length of each image is 12.4 mm. The high viscosity oil is only a jet with very few droplets. The low viscosity spray on the other hand consists of a main jet on the top with a sheet below. That sheet will later become the secondary jet that was visible in Figure 5.

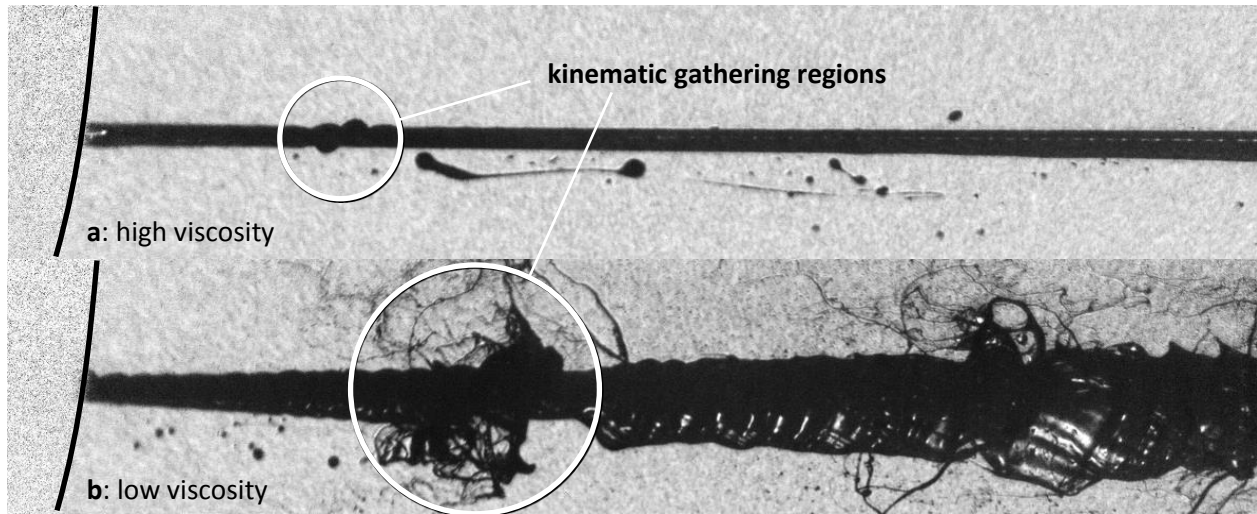

Figure 6: Near-nozzle sprays

An additional phenomena visible in these near nozzle videos is that of kinematic gathering [6]. This is where fluctuations in fluid velocity result in faster oil catching up with slower oil ahead. When this occurs, fluid is forced radially outward. This effect is more pronounced in the low viscosity spray.

Cavitation visualisation

The most likely cause of the spray splitting into multiple jets was cavitation within the nozzle. In order to test this, a second test rig was developed (Figure 7a) around an optical nozzle. The optical nozzle was designed to match the internal geometry of the Hans Jensen nozzle, based on manufacturer's drawings. The internal geometry of the nozzle consists of a 4.8 mm hole which guides the needle, prolonged by 1 mm blind hole. The exit orifice consists of a 0.3 mm hole coming out at a sharp angle near the end of the 1 mm hole. This sharp angle is expected to be a nucleation point for cavitation.

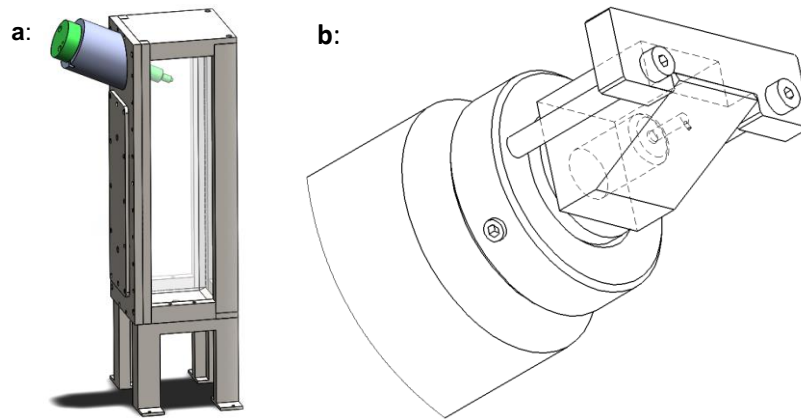

Figure 7: a) Optical injection chamber. b) Optical nozzle, mounting, and modified injector.

The nozzle was mounted to a modified injector – the nozzle end was removed and the needle retained. A mounting ring was attached to the injector body to provide a clamping point for the optical nozzle. The completed assembly of injector body, mounting ring, clamp, and optical nozzle are shown in Figure 7b.

The material chosen for the optical nozzle was acrylic, as the index of refraction closely matched that of the oil. This allowed clear visualisation of cavitation as oil within the nozzle appeared transparent, whilst any vapour pockets and air bubbles were visible as dark regions within the nozzle. Outside of the nozzle, as previously, oil spray appeared dark on a light background. The optical setup used was the same as in the previous section, with the long-range microscopic lens used in shadowgraphic configuration.

Figure 8 shows still images of the internal flow of the optical nozzle with both high (Figure 8a) and low (Figure 8b) viscosity oils. The nozzle images show the inside of the nozzle on the left-hand side, with the resultant spray on the right. Optical focus is centred within the nozzle. Although the spray lies in the same physical plane as the nozzle, the difference in the refractive index of the acrylic nozzle and the air means that the spray appears blurred in these images. Despite this blur, the general character of the spray is discernable. The dark thick border present between left and right is oil from a previous injection remaining on the surface of the nozzle. The total width of the images is 6 mm. Due to the level of magnification only the 0.3 mm exit nozzle and part of the 1 mm hole behind it are visible. Oil on the surface of the optical nozzle distorts the images slightly; however cavitation is still clearly visible within. Cavitation forms on the inside corner of the transition into the nozzle from the chamber before it. As viscosity decreases, the extent of cavitation increases. Figure 8a shows that, for the high viscosity oil, cavitation is just developing at the intersection of the 1 and 0.3 mm holes. This has little effect on the spray, which appears laminar. Figure 8b shows that for the low viscosity oil, the cavitation pocket extends the length of the nozzle – a condition known as hydraulic flip. Although out of focus, the spray is clearly affected by this condition. Fluid on the side of the spray corresponding to the cavitating region is pulled outwards. This is the cause of the splitting seen in the later stages of the spray.

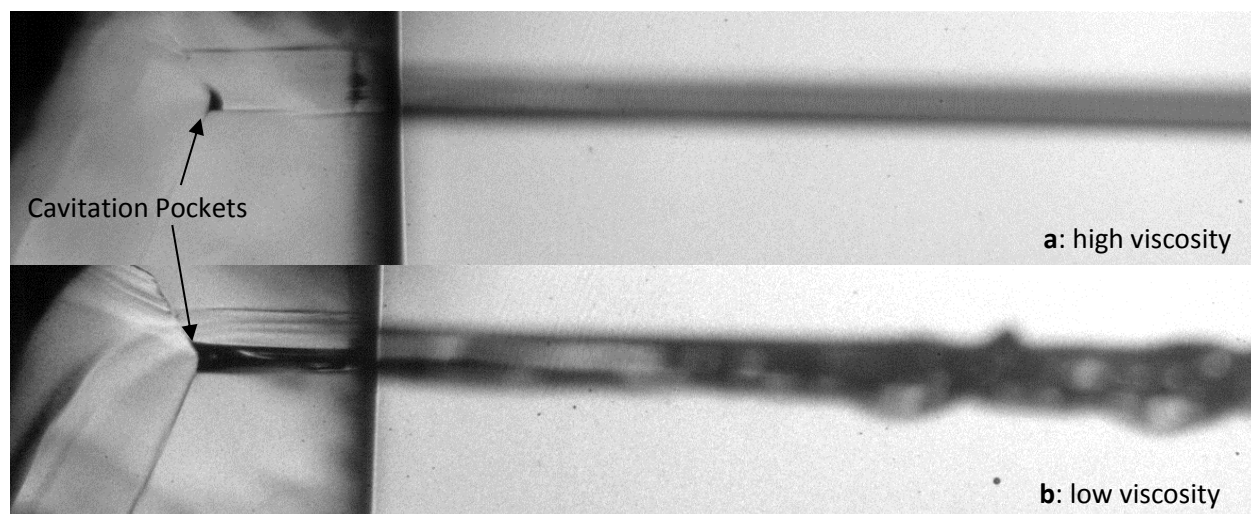

Figure 8. Internal flow with cavitation and flow at nozzle exit

Conclusion

We conducted a series of tests on a modern marine lubrication injector, visualising the near-nozzle spray, far-field spray and subsequent coverage on a transparent liner. We found that high viscosity oil resulted in a jet with compact elliptical coverage of the liner. Low viscosity oil, on the other hand resulted in a less homogeneous spray that consistently creates two separate impacts on the liner. The most likely hypothesis for this behaviour was attributed to cavitation, which was then studied using a purpose built visualisation rig and an optical transparent nozzle. This rig did indeed show evidence of cavitation, and hydraulic flip for the low viscosity oil test. The combination of the two rigs allows us to investigate the effect of cavitation, from its incipience, to its effect on the near and far field spray structure. Our findings suggest that for these injectors, certain viscosities can induce significant nozzle flow cavitation and lead to a splitting of the spray, and ultimately a less controlled liner coverage.

Whilst the system under study in the present paper comes from a single manufacturer, the focus of the research was not on the hardware but on the spray formation and subsequent oil coverage of the liner. Thus the results shown here should be applicable to other manufacturers.

Acknowledgement

The authors wish to acknowledge BP Marine and Energy Lubricants for their financial and technical support.

References

- [1] Eriksen, L., Developments in cylinder liner lubrication, in Information Conference on Recent Developments in Marine Engineering Operations 2003 (Institut für Schiffsbetriebsforschung, Flensburg, Germany). (2003)

- [2] Christensen, O., Cylinder lubrication of two-stroke crosshead marine diesel engines. Wärtsilä Technical Journal. (2010)
- [3] Lauritsen, S., Dragsted, J., and Buchholz, B., Swirl injection lubrication - a new technology to obtain low cylinder oil consumption without sacrificing wear rates, in CIMAC World Congress 2001 (Hamburg, Germany). (2001)
- [4] MAN B&W Diesel, Alpha adaptive cylinder-oil control, in CIMAC Circle 2002 (Hamburg, Germany). (2002)
- [5] Dragsted, J. and Toft, O., Influence of low cylinder consumption on operating cost for 2-stroke engines, in CIMAC Congress 2004 (Kyoto, Japan). (2004)
- [6] Eggers, J. and Villermaux, E., Physics of liquid jets. Reports on Progress in Physics. (2008)